



Hillrom™

**Welch Allyn®
KleenSpec® 800
Series Cordless
Illumination System**



Instructions for use

© 2024 Welch Allyn. All rights are reserved. To support the intended use of the product described in this publication, the purchaser of the product is permitted to copy this publication, for internal distribution only, from the media provided by Welch Allyn. No other use, reproduction, or distribution of this publication, or any part of it, is permitted without written permission from Welch Allyn. Welch Allyn assumes no responsibility for any injury to anyone, or for any illegal or improper use of the product, that may result from failure to use this product in accordance with the instructions, cautions, warnings, or statement of intended use published in this manual.

PATENT/PATENTS

For patent information, visit hillrom.com/patents.

May be covered by one or more patents. See above Internet address. The Hill-Rom companies are the proprietors of European, US, and other patents and pending patent applications.

For information about any Hill Rom product, contact your local Hill Rom representative: hillrom.com/en-us/about-us/locations.

Notice to Users and/or Patients in EU:

Any serious incident that has occurred in relation to the device should be reported to the manufacturer and the competent authority of the Member State in which the user and/or patient is established.



80030844 Ver. A

This manual applies to



901070 VAGINAL SPECULUM LIGHTING SYSTEM.

Revised 2024-06



Welch Allyn, Inc.
4341 State Street Road
Skaneateles Falls, NY 13153 USA

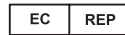

and EU Importer

Welch Allyn Limited
Navan Business Park
Dublin Road
Navan, Co Meath
C15 AW22, Ireland

Authorized Australian Sponsor
Welch Allyn Pty. Ltd. Unit 4.01,
2-4 Lyonpark Road Macquarie
Park, NSW 2113
Phone 1 800 650 083

Welch Allyn, Inc. is a subsidiary of Hill- Rom Holdings, Inc.

hillrom.com



Hillrom™

Contents

Introduction.....	1
Intended use.....	1
Contraindications.....	1
Symbols.....	1
Warnings and Cautions.....	2
Residual Risk.....	3
Use and maintain the illuminator.....	4
Charge the illuminator.....	4
Use the illuminator for a pelvic examination.....	4
Clean and disinfect.....	5
Inspect the system.....	5
Disposal.....	6
Appendices.....	7
Appendix A: Specifications.....	7
Appendix B: Accessories.....	9
Appendix C: Compatible devices.....	9
Appendix D: EMC guidance and manufacturer's declarations.....	10
Appendix E: Limited warranty	15

Introduction

Intended use

When used with the KleenSpec® Disposable Vaginal Speculum (vaginal speculum), Welch Allyn® KleenSpec 800 Series Cordless Illumination System (the illuminator) provides illumination during pelvic examinations and other gynecological procedures, such as pap smears, dilation and curettage (D&C) biopsy, and electrosurgery.

The intended users of the device are clinicians who are qualified to perform a pelvic examination. The intended environment is any location where a pelvic examination is conducted (hospital, clinic, office, long term care facility, etc.). The intended patients are all female patients who are eligible for a pelvic examination and who the clinician determines will fit with the size specula that are available (extra small, small, medium, large).





Contraindications

















The illuminator (either by itself or in conjunction with a KleenSpec vaginal speculum) is not intended to be used for eye examinations or to provide a diagnosis.

Symbols







The symbols illustrated on the following pages may appear in this Instructions for use or on the 800 Series Cordless Illuminator (illuminator) or charging station.

For information on the origin of these symbols, visit www.welchallyn.com/symbolsglossary for the Welch Allyn symbols glossary.

Symbol	Description	Symbol	Description
	<p>WARNING The warning statements in this manual identify conditions or practices that could lead to illness, injury, or death.</p> <p>Warning symbols will appear with a gray background in a black and white document.</p>		Keep dry
	<p>CAUTION The caution statements in this manual identify conditions or practices that could result in damage to the equipment or other property, or loss of data.</p>		Non-ionizing electromagnetic radiation

Symbol	Description	Symbol	Description
	Global Trade Item Number		Consult Instructions for use
R_x ONLY	For use by or on the order of a licensed medical professional		This way up
	Manufacturer		Fragile
	Separate collection of Electrical and Electronic Equipment. Do not dispose as unsorted municipal waste.		Temperature limit
	Product identifier		Humidity limitation
	Reorder number		Recyclable
	Authorized Representative in the European Community		Medical device
	Lot code		Rechargeable battery
		Li-ion	
	Approved for use in Japan		Type BF applied part when used with the KleenSpec Disposable Vaginal Speculum

Warnings and Cautions

-  **WARNING** Patient injury risk. No modifications to the illuminator is allowed. Modification of the illuminator could be hazardous to patients and personnel.
-  **WARNING** Patient injury risk. This device comes with a power supply and/or power cord that is intended for use only with this device. The power supply or power cord have not been tested and approved for use with other devices that may have the same power connectors. If you cannot locate the original power supply and/or power cord, contact Hill-Rom Technical Support: hillrom.com/en-us/about-us/locations to obtain replacement parts.
-  **WARNING** Patient injury risk. KleenSpec Cordless Illumination System is not suitable for use in the presence of a flammable anesthetic mixture with air, oxygen, or nitrous oxide. An explosion may result.
-  **WARNING** Inspect illuminator prior to use. Do not use if damaged.
-  **WARNING** To avoid eye discomfort, do not look into the beam.
-  **WARNING** Use only the cleaning methods and disinfection solutions described in this manual. Clean the device prior to disinfection.



WARNING The illuminator is a biohazard after use. Follow good hospital practices and the instructions for cleaning and disinfection of the illuminator within this manual prior to the next usage.



CAUTION Disconnect the AC power cord from the charger to the mains outlet to remove power to the device.



CAUTION The charging station and power cord are not protected from the ingress of liquid.



CAUTION Do not position any part of the illumination system in any way that makes it difficult to disconnect AC power from the device. To remove all AC power from the illumination system, unplug the external power supply from the mains outlet.



CAUTION Check low battery indicator for battery charge. Ensure battery is in good condition, not bulging or cracking before charging.

Residual Risk

This product complies with relevant electro-magnetic interference, mechanical safety, performance, and biocompatibility standards. However, the product cannot completely eliminate potential patient or user harm from the following:

- Harm or device damage associated with electro-magnetic hazards,
- Harm from mechanical hazards,
- Harm from device, function, or parameter unavailability,
- Harm from misuse error, such as inadequate cleaning, and/or
- Harm from device exposure to biological triggers that may result in a severe systemic allergic reaction.

Use and maintain the illuminator

Charge the illuminator

Charge the illuminator before using it the first time.

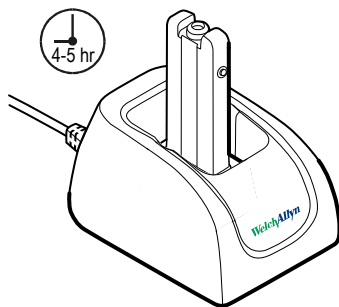

1. Connect the charging base to AC power.
2. Place the illuminator (either direction) into the charging station.
3. Remove the charged illuminator when you are ready to use it.

Full charging takes 4 to 5 hours.



NOTE It is safe to leave the illuminator in the charging station after it is charged.

The charging base has the following status indicators.

Status	Description
Off	No AC power
Green	AC power / Full charge
Amber	Illuminator inserted into charging base and is charging

Use the illuminator for a pelvic examination

1. Fully insert the illuminator into a KleenSpec Disposable Vaginal Speculum (in either direction).

2. Press the power button on the illuminator.

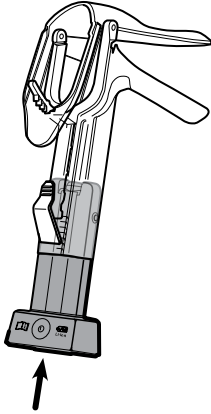

3. Complete the examination.
4. When the examination is completed, remove the speculum and press the power button to turn off the illuminator.
5. Remove the illuminator from the speculum.

Clean and disinfect

The following are approved wipes for cleaning and disinfecting.

- CaviWipes®
- Super Sani-Cloth®
- 70% isopropyl alcohol

Clean and disinfect the illuminator

Following are directions for cleaning and intermediate disinfecting of the illuminator.

1. Clean the illuminator.
 - a. Following the wipe manufacturer's instructions, wipe the entire illuminator to remove any visible debris.
 - b. Discard used wipe appropriately.
2. Disinfect the illuminator (intermediate level).
 - a. Follow wipe label instructions for appropriate contact times.
 - b. Discard used wipe appropriately.

Clean the charging base

1. Unplug the power cord.
2. Use an approved wipe to remove visible debris.
3. Discard used wipe appropriately.

Inspect the system

1. Examine all components of the cordless illumination system regularly. Components include the illuminator and charging base.
2. If any component is worn or damaged, replace it with a Welch Allyn-approved part. For ordering information, contact your local Welch Allyn® representative: hillrom.com/en-us/about-us/locations

Disposal

Disposal must be in accordance with the following steps:

1. Follow the cleaning and disinfection instructions presented in this instructions for use.
2. Segregate material in preparation for the recycling process.
3. Disassemble and recycle components based on the type of material:
 - Plastic to be recycled as plastic waste
 - Metal to be recycled as metal
 - Includes loose components containing more than 90% metal by weight
 - Includes screws and fasteners
 - Electronic components, including the power cord, to be disassembled and recycled as Waste of Electrical and Electronic Equipment (WEEE)
 - Batteries to be dismantled from the device and recycled as per WEEE



Users must adhere to all federal, state, regional, and/or local laws and regulations as it pertains to the safe disposal of medical devices and accessories. If in doubt, the user of the device shall first contact Hillrom Technical Support for guidance on safe disposal protocols.

Appendices

Appendix A: Specifications

Charging station power supply classification: US, Canada, & International; Class I and internally powered

Characteristic	Specification
Input	100-240v / 50-60Hz 160-80 mA
Output	5v DC 1400 mA
Category	Not AP/APG Equipment

Physical specifications

Characteristic	Specification
Illuminator	1.96 W x 1.37 D x 3.74 H in; 50 W x 35 D X 95 H mm
Charger	3.14 x 4.33 x 2.55-4.60 in; 80 W x 110 D X 65-117 H mm
Power supply	1.24 W x 2.16 L x 1.61 D in; 31.5 W x 55 L x 41 D mm
LED radiation output	<6.67mW at 400-750 wavelengths
Battery cell	Capacity 400mAh Voltage 3.7 V Chemistry Li-Ion Polymer Rechargeable Li-Ion Polymer Battery Charge time 4 hours On-Time use 80 minutes

Environment (temperature and humidity)

Characteristic	Specification
Operating	+10°C (50°F) and +35°C (95°F) 700 hPa - 1060 hPa 30% - 75% non-condensing
Transport/Storage	-20°C (-4°F) and +49°C (120°F) 500 hPa - 1060 hPa 15% - 95% non-condensing

Operation

When used with the vaginal speculum, the cordless illuminator provides illumination during pelvic examinations and other gynecological procedures, such as pap smears, dilation and curettage (D&C), biopsy, and electrosurgery.

Safety, EMC and regulatory compliance

UL 60601-1 Medical Electrical Equipment, Part 1: General Requirements for Safety

CAN/CSA C22.2 No. 601.1-M90 Medical Electrical Equipment, Part 1: General Requirements for Safety

IEC 60601-1 Medical Electrical Equipment, Part 1: General Requirements for Safety, and associated CB Scheme Report and Certificate.

EN 60601-1 Medical Electrical Equipment, Part 1: General Requirements for Safety

EN 60601-1-2 Medical Electrical Equipment, Part 1-2: General Requirements for Safety – Collateral Standard: Electromagnetic Compatibility – Requirements and Tests

CISPR 11/EN 55011/AS_NZS CISPR 11, RF Emissions

CISPR 11, Conducted Emissions

47 CFR Part 18

This device complies with Part 18 of the FCC rules.

Lot Code







Lot: YYYY/MM/DD

YYYY=Year of manufacture

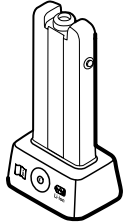
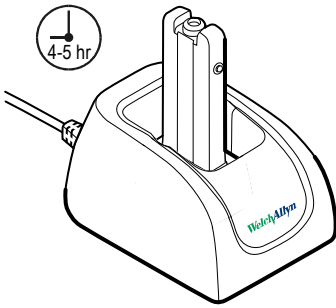
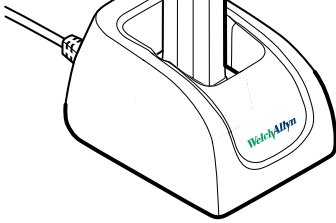
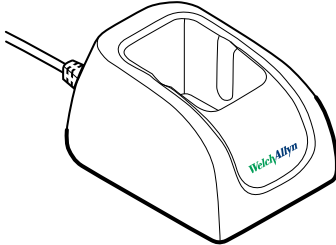
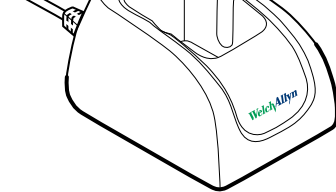
MM=Month of manufacture

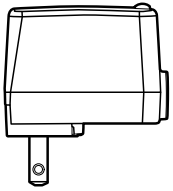
DD=Day of manufacture

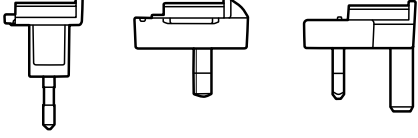
Appendix B: Accessories

Part number	Description	Illustration
80000	KleenSpec Vaginal Speculum Cordless Illuminator	
80010	KleenSpec Vaginal Speculum Cordless Illuminator with Charging Station/Domestic	
80015	KleenSpec Vaginal Speculum Cordless Illuminator with Charging Station/International	
74010	KleenSpec Charging Station/Domestic	
74015	KleenSpec Charging Station/International	
FW8002MUSB/05	Power Supply  NOTE Available only with the 74010, 74015, 80010, and 80015 Charging Stations	
1899414	International Power Supply Adaptor Kit  NOTE Available only with the 74015 and 80015 Charging Stations.	
	 NOTE USB Cable is not sold separately.	

Appendix C: Compatible devices

KleenSpec Vaginal Specula—Premium 590 Series

590XS KleenSpec 590 Series Premium Disposable Vaginal Specula, X-Small

59000 KleenSpec 590 Series Premium Disposable Vaginal Specula, Small

59001 KleenSpec 590 Series Premium Disposable Vaginal Specula, Medium

59004 KleenSpec 590 Series Premium Disposable Vaginal Specula, Large

KleenSpec Vaginal Specula—Premium 590 Series with Smoke Tube

59005 KleenSpec 590 Series Premium Disposable Vaginal Specula with Smoke Tube, Small

59006 KleenSpec 590 Series Premium Disposable Vaginal Specula with Smoke Tube, Medium

Appendix D: EMC guidance and manufacturer's declarations

EMC compliance

Special precautions concerning electromagnetic compatibility (EMC) must be taken for all medical electrical equipment. This device complies with IEC 60601-1-2/EN 60601-1-2.

- All medical electrical equipment must be installed and put into service in accordance with the EMC information provided in this Instructions for use.
- Portable and mobile RF communications equipment can affect the behavior of medical electrical equipment.

The device complies with all applicable and required standards for electromagnetic interference.

- It does not normally affect nearby equipment and devices.
- It is not normally affected by nearby equipment and devices.
- It is not safe to operate the device in the presence of high-frequency surgical equipment.
- However, it is good practice to avoid using the device in extremely close proximity to other equipment.



WARNING The use of the 800 Series adjacent to or stacked with other equipment or medical electrical systems should be avoided because it could result in improper operation. If such use is necessary, the 800 Series and other equipment should be observed to verify that they are operating normally.



WARNING Use only accessories recommended by Hill Rom for use with the 800 Series. Accessories not recommended by Hill Rom may affect the EMC emissions or immunity.



WARNING Maintain minimum separation distance between the 800 Series and portable RF communication equipment. Performance of the 800 Series may be degraded if proper distance is not maintained.

Emissions and immunity information

Electromagnetic emissions

The Welch Allyn KleenSpec 800 Series is intended for use in the electromagnetic environment specified below. The customer or user of the 800 Series should assure that it is used in such an environment.

Emissions test	Compliance	Electromagnetic environment - guidance
RF emissions CISPR 11	Group 1	The 800 Series uses RF energy only for its internal function. Therefore, its RF emissions are very low and are not likely to cause any interference in nearby electronic equipment.

Emissions test	Compliance	Electromagnetic environment - guidance
RF emissions CISPR 11	Class B	The 800 Series is suitable for use in all establishments, including domestic establishments and those directly connected to the public low voltage power supply network that supplies buildings used for domestic purposes.
Harmonic emissions IEC 61000-3-2	Class A	 WARNING This equipment/system is intended for use by healthcare professionals only. This equipment/ system may cause radio interference or may disrupt the operation of nearby equipment. It may be necessary to take mitigation measures, such as re-orienting or relocating the 800 Series or shielding the location.
Voltage fluctuations/flicker emissions IEC 61000-3-3	Complies	

Electromagnetic immunity

The 800 Series is intended for use in the electromagnetic environment specified below. The customer or the user of the 800 Series should assure that it is used in such an environment.

Immunity test	IEC 60601 test level	Compliance level	Electromagnetic environment - guidance
Electrostatic discharge (ESD) IEC 61000-4-2	±8 kV contact ±2 kV, ±4kV, ±8 kV, ±15 kV air	±8 kV contact ±2 kV, ±4 kV, ±8 kV, ±15 kV air	Floors should be wood, concrete or ceramic tile. If floors are covered with synthetic material, the relative humidity should be at least 30%.
Electrical fast transient/burst IEC 61000-4-4	±2 kV for power supply lines ±1 kV for input/output lines	±2 kV ±1 kV	Mains power quality should be that of a typical commercial or hospital environment.
Surge IEC 61000-4-5	±0.5 kV, ±1 kV Line-to-line ±0.5 kV, ±1 kV, ±2 kV Line-to-ground	±1 kV ±2 kV	Mains power quality should be that of a typical commercial or hospital environment.

Immunity test	IEC 60601 test level	Compliance level	Electromagnetic environment - guidance
Voltage dips, short interruptions and voltage variations on power supply input lines IEC 61000-4-11	0 % U _T ; 0.5 cycle	0 % U _T ; 0.5 cycle	Mains power quality should be that of a typical commercial or hospital environment. If the user of the 800 Series requires continued operation during power mains interruptions, it is recommended that the 800 Series be powered from an uninterruptible power supply or a battery.
	At 0°, 45°, 90°, 135°, 180°, 225°, 270° and 315°		
	0 % U _T ; 1 cycle	0 % U _T ; 1 cycle	
	70 % U _T ; 25/30 cycles Single phase: at 0°	70 % U _T ; 25/30 cycles	
	0 % U _T ; 250/300 cycle	0 % U _T ; 250/300 cycle	
Power frequency (50/60 Hz) magnetic field IEC 61000-4-8	30 A/m	30 A/m	Power frequency magnetic fields should be at levels characteristic of a typical location in a typical commercial or hospital environment.



NOTE U_T is the a.c. mains voltage prior to application of the test level.

Electromagnetic immunity

The 800 Series is intended for use in the electromagnetic environment specified below. The customer or the user of the 800 Series should assure that it is used in such an environment.

Immunity test	IEC 60601 test level	Compliance level	Electromagnetic environment - guidance
			Portable and mobile RF communications equipment should be used no closer to any part of the 800 Series, including cables, than the recommended separation distance calculated from the equation applicable to the frequency of the transmitter.
			<i>Recommended separation distance</i>
Conducted RF IEC 61000-4-6	3 Vrms	3 Vrms	$d = \left[\frac{3.5}{V_1} \right] \sqrt{P}$
	150 kHz to 80 MHz	150 kHz to 80 MHz	
	6Vrms in ISM and amateur radio bands between 150 kHz and 80 MHz. 80% AM at 1kHz	6Vrms in ISM and amateur radio bands between 150 kHz and 80 MHz. 80% AM at 1kHz	$d = \left[\frac{12}{V_2} \right] \sqrt{P}$

Immunity test	IEC 60601 test level	Compliance level	Electromagnetic environment - guidance
Radiated RF IEC 61000-4-3	10 V/M, 80 MHz to 2.7 GHz 80% AM at 1 kHz	10 V/M, 80 MHz to 2.7 GHz 80% AM at 1 kHz	$d = \left[\frac{23}{E_1} \right] \sqrt{P}$ 800 MHz to 2.7 GHz $d = \left[\frac{12}{E_1} \right] \sqrt{P}$ 80 MHz to 800 MHz where P is the maximum output power rating of the transmitter in watts (W) and d is the recommended separation distance in meters (m). Field strengths from fixed RF transmitters, as determined by an electromagnetic site survey ¹ , should be less than the compliance level in each frequency range ² . Interference may occur in the vicinity of equipment marked with the following symbol: 

¹ Field strengths from fixed transmitters, such as base stations for radio (cellular/cordless) telephones and land mobile radios, amateur radio, AM and FM radio broadcast, and TV broadcast cannot be predicted theoretically with accuracy. To assess the electromagnetic environment due to fixed RF transmitters, an electromagnetic site survey should be considered. If the measured field strength in the location in which the 800 Series is used exceeds the applicable RF compliance level above, the 800 Series should be observed to verify normal operation. If abnormal performance is observed, additional measures may be necessary, such as reorienting or relocating the 800 Series.

² Over the frequency range 150 kHz to 80 MHz, field strengths should be less than 3 V/m.



NOTE At 80 MHz and 800 MHz, the higher frequency range applies.



NOTE These guidelines may not apply in all situations. Electromagnetic propagation is affected by absorption and reflection from structures, objects, and people.

Test specifications

Test specifications for ENCLOSURE PORT IMMUNITY to proximity magnetic fields

Test frequency	Modulation	IMMUNITY TEST LEVEL (A/m)
30 kHz	CW	8
134,2 kHz	Pulse modulation ¹ 2,1 kHz	65 ²
13,56 MHz	Pulse modulation ¹ 50 kHz	7,5 ²

Test frequency	Modulation	IMMUNITY TEST LEVEL (A/m)
¹ The carrier shall be modulated using a 50% duty cycle square wave signal. ² r.m.s. before modulation is applied		

Recommended separation distances between portable and mobile RF communications equipment and the 800 Series

The 800 Series is intended for use in an electromagnetic environment in which radiated RF disturbances are controlled. The customer or user of the 800 Series can help prevent electromagnetic interference by maintaining a minimum distance between portable and mobile RF communications equipment (transmitters) and the 800 Series as recommended below, according to the maximum output power of the communications equipment.

Rated max. output power of transmitter (W)	Separation distance according to frequency of transmitter (m)			
	150 kHz to 80 MHz outside ISM bands	150 kHz to 80 MHz in ISM bands	80 MHz to 800 MHz	800 MHz to 2.7 GHz
	$d = \left[\frac{3.5}{V_1}\right]\sqrt{P}$	$d = \left[\frac{12}{V_2}\right]\sqrt{P}$	$d = \left[\frac{12}{E_1}\right]\sqrt{P}$	$d = \left[\frac{23}{E_1}\right]\sqrt{P}$
0.01	0.12	0.20	0.12	0.23
0.1	0.37	0.63	0.38	0.73
1	1.17	2.00	1.20	2.30
10	3.69	6.32	3.79	7.27
100	11.67	20.00	12.00	23.00

For transmitters rated at a maximum output power not listed above, the recommended separation distance in meters (m) can be estimated using the equation applicable to the frequency of the transmitter, where P is the maximum output power rating of the transmitter in watts (W) according to the transmitter manufacturer.



NOTE At 80 MHz and 800 MHz, the separation distance for the higher frequency range applies.



NOTE These guidelines may not apply in all situations. Electromagnetic propagation is affected by absorption and reflection from structures, objects, and people.

Test specifications for enclosure port immunity to RF wireless communications equipment

Test frequency (MHz)	Band ¹ (MHz)	Service ¹	Modulation ²	Maximum power (W)	Distance (m)	Immunity test level (V/m)
385	380 - 390	TETRA 400	Pulse modulation ² 18 Hz	1.8	0.3	27
450	430 - 470	GMRS 460, FRS 460	FM ³ ±5 kHz deviation 1 kHz sine	2	0.3	28

710	704 - 787	LTE band 13, 17	Pulse modulation ²	0.2	0.3	9
745			217 Hz			
780						
810	800 - 960	GSM 800/900, TETRA 800, iDEN 820, CDMA 850,	Pulse modulation ²	2	0.3	28
870			18 Hz			
930		LTE Band 5				
1720	1700 - 1990	GSM 1800; CDMA 1900; GSM 1900; DECT; LTE Band 1, 3, 4, 25; UMTS	Pulse modulation ²	2	0.3	28
1845			217 Hz			
1970						
2450	2400 - 2570	Bluetooth, WLAN, 802.11 b/g/n, RFID 2450, LTE Band 7	Pulse modulation ²	2	0.3	28
			217 Hz			
5240	5100 - 5800	WLAN 802.11 a/n	Pulse modulation ²	0.2	0.3	9
5500			217 Hz			
5785						

¹ For some services, only the uplink frequencies are included.

² The carrier shall be modulated using a 50 percent duty cycle square wave signal.

³ As an alternative to FM modulation, 50 percent pulse modulation at 18 Hz may be used because while it does not represent actual modulation, it would be worst case.

Appendix E: Limited warranty

Hill Rom warrants the product to be free of defects in material and workmanship and to perform in accordance with manufacturer's specifications for the period of one year from the date of purchase from Hill Rom or its authorized distributors or agents.

The warranty period shall start on the date of purchase. The date of purchase is: 1) the invoiced ship date if the device was purchased directly from Hill Rom, 2) the date specified during product registration, 3) the date of purchase of the product from a Hill Rom authorized distributor as documented from a receipt from said distributor.

This warranty does not cover damage caused by: 1) handling during shipping, 2) use or maintenance contrary to labeled instructions, 3) alteration or repair by anyone not authorized by Welch Allyn, and 4) accidents.

The product warranty is also subject to the following terms and limitations: Accessories are not covered by the warranty. Refer to the instructions for use provided with individual accessories for warranty information.

Shipping cost to return a device to a Hill Rom service center is not included.

A service notification number must be obtained from Hill Rom prior to returning any products or accessories to Hill Rom's designated service centers for repair. To obtain a service notification number, contact Hill Rom Technical Support at hillrom.com/en-us/about-us/locations.

THIS WARRANTY IS IN LIEU OF ALL OTHER WARRANTIES, EXPRESS OR IMPLIED, INCLUDING BUT NOT LIMITED TO THE IMPLIED WARRANTIES OF MERCHANTABILITY AND FITNESS FOR A PARTICULAR PURPOSE. WELCH ALLYN'S OBLIGATION UNDER THIS WARRANTY IS LIMITED TO REPAIR OR REPLACEMENT OF PRODUCTS CONTAINING A

DEFECT. WELCH ALLYN IS NOT RESPONSIBLE FOR ANY INDIRECT OR CONSEQUENTIAL DAMAGES RESULTING FROM A PRODUCT DEFECT COVERED BY THE WARRANTY.

