



Hillrom™

**Welch Allyn®
Connex® ProBP™ 3400
digital blood pressure device**



Instructions for use

Software version 1.04.XX

© 2021 Hillrom. All rights are reserved. To support the intended use of the product described in this publication, the purchaser of the product is permitted to copy this publication, for internal distribution only, from the media provided by Hillrom. No other use, reproduction, or distribution of this publication, or any part of it, is permitted without written permission from Hillrom.

Hillrom assumes no responsibility for any injury to anyone, or for any illegal or improper use of the product, that may result from failure to use this product in accordance with the instructions, cautions, warnings, or statement of intended use published in this manual.

Welch Allyn, SureBP Technology, and Welch Allyn FlexiPort are registered trademarks of Welch Allyn. The *Bluetooth*® word mark and logos are registered trademarks owned by *Bluetooth* SIG, Inc. and any use of such marks by Welch Allyn is under license.

Software in this product is Copyright 2021 Welch Allyn or its vendors. All rights are reserved. The software is protected by United States of America copyright laws and international treaty provisions applicable worldwide. Under such laws, the licensee is entitled to use the copy of the software incorporated with this instrument as intended in the operation of the product in which it is embedded. The software may not be copied, decompiled, reverse-engineered, disassembled, or otherwise reduced to human-perceivable form. This is not a sale of the software or any copy of the software; all right, title, and ownership of the software remain with Welch Allyn or its vendors.

For information about any Welch Allyn product, contact Hillrom Technical Support <http://www.hillrom.com/en/about-us/locations.html>.



80028319 Ver. A Revision date: 2021-04

This manual applies to  901055 DIGITAL BLOOD PRESSURE DEVICE



Welch Allyn, Inc.
4341 State Street Road
Skaneateles Falls, NY 13153 USA
hillrom.com

Welch Allyn, Inc. is a subsidiary of Hillrom Holdings, Inc.

PATENTS hillrom.com/patents

May be covered by one or more patents. See above Internet address.

The Hill-Rom companies are the proprietors of European, US, and other patents and pending patent applications.

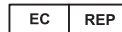

AND EU IMPORTER

Welch Allyn Limited
Navan Business Park, Dublin Road,
Navan, County Meath, C15 AW22
Ireland

Authorized Australian Sponsor

Welch Allyn Australia Pty. Ltd.

Unit 4.01, 2-4 Lyonpark Road

Macquarie Park, NSW 2113

Phone 1800 650 083



Contents

Initial device setup	1
Introduction	3
Intended use	3
Symbols	5
General warnings and cautions	9
NIBP warnings and cautions	13
Contents checklist	15
Controls and indicators	17
Screen elements	19
Connections	21
Blood pressure hose and cuff	23
Blood pressure cuff selection	23
Power transformer	25
Power transformer and wall plug	25
Charge the device	26
Setup	27
Insert the battery	27
Assemble power cord and wall plug/line cord assembly	28
Charge the ProBP 3400	28
Mount the device	29
Initial startup	29

Battery	31
Startup	33
Blood pressure procedure	35
Blood pressure measurement	35
Obtain blood pressure measurement	36
Settings	37
Settings matrix	37
Unit of measure	37
Pressure presets	38
Bluetooth wireless technology	38
Advanced settings	39
Data review	43
Review data	43
Delete data	43
Maintenance and service	45
Inspection	45
Calibrate the device	45
Change the battery	45
Clean the device	46
Specifications	49
Physical specifications	49
Mechanical specifications	49
Electrical specifications	50
Environmental specifications	50
Product disposal	52
Standards and compliance	53
General safety compliance	53
General radio compliance	53
Guidance and manufacturer's declaration	55
EMC compliance	55
Emissions and immunity information	56
Warranty	63
Troubleshooting	65
Inaccurate blood pressure readings	65
Cuff inflation and deflation with no blood pressure reading displayed	66
No cuff inflation	67
Cuff pops off	67
Cuff deflating too slowly	67
Device does not turn on	68
Bluetooth troubleshooting	68

Appendix	71
ProBP 3400 approved accessories	71
Configuration options	73

Initial device setup

Before using ProBP 3400 digital blood pressure device (ProBP 3400) for the first time, you must configure the device for use. See Setup for additional information.

Introduction

This Instructions for use manual is a comprehensive guide designed to help you understand the capabilities and operation of the ProBP 3400 non-invasive blood pressure device. The information in this manual includes all options available with the device. Read this manual thoroughly before attempting to setup, configure, use, troubleshoot, or maintain the device.

Intended use

The ProBP 3400 automatically measures systolic and diastolic pressure (excluding neonates) and pulse rate, as well as calculates Mean Arterial Pressure (MAP).

The device is intended to be used by clinicians and medically qualified personnel. It is available for sale only upon the order of a physician or licensed health care provider.

This device is not intended for use on neonates, infants, or children under the age of 3 years. The effectiveness of this device has not been established in pregnant, including pre-eclamptic, patients.

Symbols

For information on the origin of these symbols, see the Welch Allyn symbols glossary: welchallyn.com/symbolsglossary

Documentation symbols



WARNING The warning statements in this manual identify conditions or practices that could lead to illness, injury, or death.



CAUTION The caution statements in this manual identify conditions or practices that could result in damage to the equipment or other property, or loss of data.



Follow instructions for use (IFU) -- mandatory action. A copy of the IFU is available on this website. A printed copy of the IFU can be ordered from Welch Allyn for delivery within 7 calendar days.

Power symbols



(green indicator) External power present, battery charged



Battery charging



(amber indicator) External power present, battery is charging



Rechargeable battery



No external power present



Battery charge level

Button symbols



Power on/standby



Return to previous screen



Blood Pressure Start/Stop



Select



Navigation (Up, Down, Left, Right)

Shipping, storing, and environment symbols



Fragile; handle with care



Humidity limitation



Temperature limits

Li-ion

Lithium-ion battery



Recovery/Recyclable



Separate collection of Electrical and Electronic Equipment. Do not dispose as unsorted municipal waste.



This end up



Keep dry

IPX0

Equipment is not protected against the ingress of liquid

GTIN

Global Trade Item Number

Connectivity symbols



Bluetooth® wireless technology enabled



USB connection



Devices are connected via Bluetooth wireless technology



Bluetooth radio is disabled or not paired

Miscellaneous symbols



Meets essential requirements of European Medical Device Directive 93/42/EEC

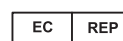

Authorized Representative in the European Community.



Product Identifier



Wireless radio alert in Europe. European Communities Class 1 radio equipment.



Intertek ETL listed



Class II equipment



Serial number



Reorder number



Non-ionizing electromagnetic radiation



Medical device



Australian Communications and Media Authority (ACMA) Radio Compliance Mark (RCM).



Type BF applied parts



For Use by or on the order of a licensed medical professional.



Manufacturer



Call for maintenance



Mass in kilograms (kg)

General warnings and cautions



WARNING The information in this instructions for use is a comprehensive guide to the operation of ProBP 3400. For best results, read this instructions for use thoroughly before using the device.



WARNING The device is designed for medical clinician use. Although this instructions for use may illustrate medical spot-check techniques, only a trained clinician who knows how to take and interpret a patient's vital signs should use this device.



WARNING The device is intended for use only in environments with clinician supervision.



WARNING The device is not intended for continuous monitoring. Do not leave the device unattended while taking measurements on a patient.



WARNING The device is not intended for use during patient transport.



WARNING Fire and explosion hazard. Do not operate the device in the presence of a flammable anesthetic mixture with air, oxygen, or nitrous oxide; in oxygen-enriched environments; or in any other potentially explosive environment.



WARNING Use only Welch Allyn approved accessories. Use of unapproved accessories with the device can affect patient and operator safety, and can reduce product performance and accuracy. To ensure patient safety and optimal product performance, use only accessories and supplies recommended for or supplied with the device, and use according to the accessory manufacturer's instructions for use.



WARNING Every three months, inspect the blood pressure cuff and other accessories for fraying or other damage. Replace as necessary.



WARNING Inaccurate measurement risk. Do not use the device on patients who are connected to heart/lung machines.



WARNING Electric shock hazard. Do not open the device or attempt repairs. There are no user-serviceable parts inside ProBP 3400 other than battery replacement. Only perform routine cleaning and maintenance procedures specifically described in this instructions for use. Inspection and servicing of internal parts shall only be performed by qualified service personnel.



WARNING The device complies with applicable domestic and international standards for electromagnetic interference and should not present problems to other equipment or be affected by other devices. As a precaution, avoid using the device in close proximity to other equipment.



WARNING Welch Allyn is not responsible for the integrity of any mounting installation. Welch Allyn recommends that customers contact their Biomedical Engineering Department or maintenance service to ensure professional installation for safety and reliability of any mounting accessory.



WARNING The device is not defibrillator proof.



WARNING The device may not function properly if dropped or damaged. Do not use the device if you notice any signs of damage. Qualified service personnel must check any device that is dropped or damaged for proper operation before putting the device back into use.



WARNING Defective batteries can damage the device. If the battery shows any signs of damage, leakage, or cracking, it must be replaced immediately, and only with a battery recommended for or supplied with the device.



WARNING Improper disposal of batteries may create an explosion or contamination hazard. Never dispose of batteries in refuse containers. Do not dispose of the battery in fire. Always recycle batteries according to local regulations.



WARNING Improper handling of the battery can lead to heat generation, smoke, bursting, or fire.



WARNING Do not remove the label from the battery.



WARNING Do not disassemble, modify, or solder the battery.



WARNING Do not directly connect or short circuit the positive (+) and negative (-) battery terminals.



WARNING To avoid short circuits, keep battery terminals away from metal objects.



WARNING Do not expose the battery to temperatures higher than 80 °C/176 °F.



WARNING If the accuracy of any measurement is in question, check the patient's vital sign(s) with an alternate method and then check to verify the device is functioning properly.



WARNING For proper patient electrical isolation and battery charging, use only the provided external power supply to charge the device.



WARNING Electric shock hazard. Use the USB connector only to connect to devices complying with IEC 60601-1 or other IEC standards as appropriate to the device. The user is responsible for verifying that the system complies with the requirements of the system standard IEC 60601-1-1 if additional devices are connected to the ProBP 3400.



WARNING Electric shock hazard. Before cleaning the device, disconnect the power cord from the power source and the device. Ensure that the power transformer and wall plug assembly are dry before plugging into an outlet.



WARNING Electric Shock Hazard. If you clean the power transformer, take the following precautions:

- Ensure the power transformer is unplugged from the outlet.
- Ensure that the cleaning cloth is not dripping or over saturated.
- Apply minimal pressure on the wipe or cloth when cleaning; avoid wiping the gap or connection areas on the power transformer and wall plug.
- Ensure the power transformer, wall plug, and cord are dry before plugging into an outlet.



WARNING Take care to prevent water or other fluid from entering any connectors on the device, power transformer and wall plug. Should this occur, dry the connectors with warm air. Check the accuracy of all operating functions.



CAUTION The device is not heat-resistant. Do not autoclave.



CAUTION Use the device within stated operating temperature ranges. The device will not meet performance specifications if used outside these temperatures ranges.



CAUTION Always unplug the external power source from the outlet before moving the device to a new location.

Notice to users and/or patients in EU Any serious incident that has occurred in relation to the device, should be reported to the manufacturer and the competent authority of the Member State in which the user and/or patient is established.

NIBP warnings and cautions



WARNING ProBP 3400 is not intended to measure blood pressure on neonatal patients. The AAMI SP10:2002 standard defines neonates as children 28 days or less of age if born at term (37 weeks gestation or more); otherwise up to 44 gestational weeks.



WARNING This device is not intended for use on neonates, infants, or children under the age of 3 years. The effectiveness of this device has not been established in pregnant, including pre-eclamptic, patients.



WARNING To ensure pediatric blood pressure accuracy and safety, the Small Child Reusable Cuff (REUSE-08) is the smallest cuff approved for use with young children.



WARNING Do not compress the blood pressure hose or cuff. This may cause system errors or patient safety risks to occur.



WARNING NIBP readings may be inaccurate for patients experiencing moderate to severe arrhythmia.



WARNING Inaccurate measurement risk. Do not use the device on patients who are experiencing convulsions or tremors.



WARNING Use only blood pressure cuffs and hoses listed as approved accessories to ensure safe and accurate NIBP measurements.



WARNING Patient injury risk. When several blood pressure measurements are taken on the same patient, regularly check the cuff site and extremity for possible ischemia, purpura, and/or neuropathy.



WARNING Do not allow a blood pressure cuff to remain on the patient more than 3 minutes when inflated above 15 mmHg. Excessive cuff tightness may cause venous congestion, peripheral nerve injury, discoloration of the limb, and patient distress.



WARNING Inaccurate measurement risk. Do not place the cuff where it can disturb proper circulation. Do not place the cuff on any area where circulation is compromised or on any extremity used for intravenous infusions.



WARNING The blood pressure cuff must be properly positioned to ensure blood pressure accuracy and patient safety. Wrapping the cuff too loosely (preventing proper inflation) may result in inaccurate NIBP readings.



WARNING Patient injury risk. Never install Luer Lock connectors on Welch Allyn blood pressure tubing. Using these connectors on blood pressure cuff tubing creates the risk of mistakenly connecting this tubing to a patient's intravenous line and introducing air into the patient's circulatory system.



WARNING NIBP measurements may be inaccurate in the presence of excessive motion artifact. Minimize extremity and cuff motion during blood pressure readings.



WARNING The position and physiologic condition of the subject can affect a blood pressure reading.



WARNING If the blood pressure cuff is not at heart level, note the difference in reading due to the hydrostatic effect. Add the value of .2 kPa (1.80 mmHg) to the displayed reading for every 2.5 cm (inch) above heart level. Subtract the value of .2 kPa (1.80 mmHg) from the displayed reading for every 2.5 cm (inch) below heart level.



WARNING Proper blood pressure cuff size and placement is essential to the accuracy of the blood pressure determination. See Blood pressure cuff selection for sizing information.



WARNING Continuous cuff pressure due to connection tubing kinking may result in blood flow interference and harmful injury may occur to the patient.



WARNING Frequent measurements can cause injury to the patient due to blood flow interference.



WARNING Do not place the cuff over a wound as this can cause further injury.



WARNING Blood flow interference may result if the application of the cuff and its pressurization on any limb where intravascular access or therapy, or an arterio-venous (A-V) shunt is present and could result in injury to the patient.



WARNING Avoid pressurizing a cuff on the arm side of a mastectomy.



WARNING Pressurization of the cuff may result in temporary loss of function of simultaneous used monitoring equipment applied on the same limb as the cuff.



WARNING The automated sphygmomanometer needs to be checked to ensure that its operation does not result in prolonged impairment of blood circulation of the patient.

Contents checklist

Unpack the ProBP 3400 and any applicable accessories and inspect for missing items. Retain the shipping materials in the event of shipping damage or for return, if necessary, to Welch Allyn for repair or warranty service. Report any signs of shipping damage to the carrier. Report any missing or damaged items to the Welch Allyn Service Center near you.

All ProBP 3400 devices include the following components:

ProBP 3400 Device. This device automatically measures systolic and diastolic pressure (excluding neonates) and pulse rate, as well as calculates Mean Arterial Pressure (MAP).

Instructions for Use CD. Read this Instructions for Use thoroughly before using the ProBP 3400. Save this CD for reference.

Battery. Install the battery before using the device. See Battery for additional information.

Blood Pressure Cuff(s). See Blood pressure hose and cuff for additional information.

Blood Pressure Hose. Pressure hose, not made with natural rubber latex, with connectors to attach various sizes of blood pressure cuffs to the Welch Allyn ProBP 3400 device.

USB Cable. Attaches to Power Transformer and device to provide power to the ProBP 3400 and charge the internal battery.

Power Transformer and Wall Plug/Line Cord. Power transformer and wall plug (or line cord) assembles and attaches to USB cable to provide power to the ProBP 3400 and charge the internal battery.

Startup Guide. Use the Startup Guide to setup device for first-time use.

Warranty. Complete the ProBP 3400 warranty today at www.welchallyn.com/warranty.

Controls and indicators

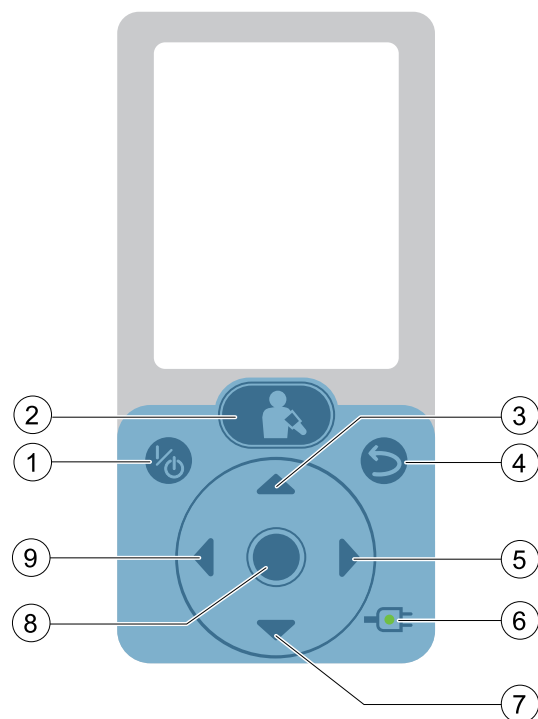

1. **Power on/standby** button: controls power to the device.
2. **Blood Pressure Start/Stop** button: initiates a new blood pressure cycle from the Home screen. Pressing again aborts an active blood pressure measurement. This button returns user to the Home screen from any other screen on the device.
3. **Up navigation** button: highlights the previous option in the Display window or increases numeric values.
4. **Return** button: returns the user to the previous screen.
5. **Right navigation** button: highlights the Settings tab in the Display window or highlights options to the right.
6. **Charging** LED: indicates when device is connected to external power and battery charging state.
7. **Down navigation** button: highlights the next option in the Display window or decreases numeric values.
8. **Select** button: selects list item that has been highlighted.
9. **Left navigation** button: highlights the Review tab in the Display window or highlights options to the left.

Screen elements

The display may indicate any of the following: systolic blood pressure (mmHg or kPa), diastolic blood pressure (mmHg or kPa), MAP (mmHg or kPa), pulse rate (bpm), date, time, record number, and battery charge level.



NOTE Your model may not contain all of these options.

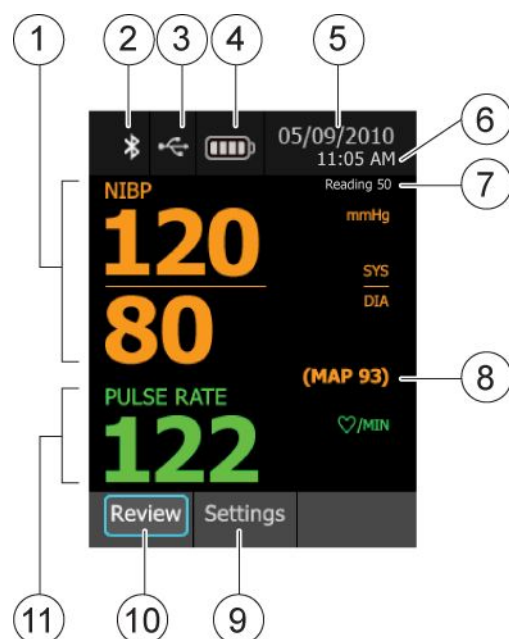

1. **NIBP display:** shows systolic and diastolic values of NIBP readings.
2. **Bluetooth radio status (if equipped):** indicates status of *Bluetooth* radio.
3. **USB:** indicates USB is connected.
4. **Battery level indicator:** displays the battery charge level.
5. **Date:** shows the current date.
6. **Clock:** shows the current time.
7. **Reading number identified:** shows what reading the device is on. The ProBP 3400 device retains up to 50 readings in memory.
8. **MAP:** shows the MAP value.
9. **Settings:** displays the Settings menu, when selected.
10. **Review:** displays the Review menu, when selected.
11. **Pulse rate display:** shows the pulse rate.

Connections

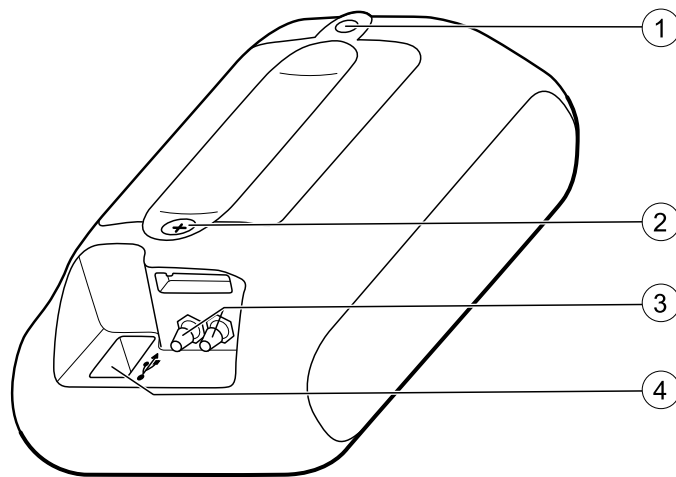

1. Mounting connection
2. Battery door screw
3. Blood pressure hose connection port
4. USB/external power cord connection port

Blood pressure hose and cuff

Identify and have available the ProBP 3400, blood pressure cuff, and the blood pressure hose.

1. Inspect the blood pressure hose; notice that one end has a single, gray Welch Allyn FlexiPort fitting and the other end is plain with two recessed holes.
2. Completely push the plain end of the blood pressure hose onto the two silver blood pressure ports on the device. Make sure the hose is fully seated.
3. Snap the Welch Allyn FlexiPort connector onto the blood pressure cuff.

Blood pressure cuff selection

Careful sizing of the cuff is important for accurate blood pressure readings. If the cuff is too small or too large, you may have false high or low readings, respectively. When there is an area of overlap for using a smaller or larger cuff, use the larger size cuff.

The device uses oscillometric technology to determine blood pressure; therefore, if the cuff extends to the antecubital fossa (bend in the elbow), you can still acquire an accurate blood pressure reading.

Measure the arm circumference (midway between the elbow and shoulder) for the correct cuff size.

Wrap the cuff around the patient's upper arm and verify that the artery index marker falls within the two divisions that identify the "range" on the cuff to indicate a proper fit.

The following table provides measurements for Welch Allyn blood pressure cuffs.

Cuff Size	Reusable One-Piece Cuff (1 per pack)	Circumference (cm)	Circumference (in)
Small child (size 8)	Reuse-08	12.0 – 16.0	4.7 – 6.3
Child (size 9)	Reuse-09	15.0 – 21.0	5.9 – 8.3
Small adult (size 10)	Reuse-10	20.0 – 26.0	7.9 – 10.2
Adult (size 11)	Reuse-11	25.0 – 34.0	9.8 – 13.4
Adult long (size 11L)	Reuse-11L	25.0 – 34.0	9.8 – 13.4
Large adult (size 12)	Reuse-12	32.0 – 43.0	12.6 – 16.9
Large adult long (size 12L)	Reuse-12L	32.0 – 43.0	12.6 – 16.9
Thigh (size 13)	Reuse-13	40.0 – 55.0	15.7 – 21.7

For ordering information, see the ProBP 3400 approved accessories in the Appendix.

Power transformer

Power transformer and wall plug

The power transformer and wall plug are packaged separately and must be assembled prior to use. The instructions below are for using the power transformer with the wall or desk mount configuration. If you have the mobile stand configuration, refer to the assembly instructions that are included with the stand for power transformer connection.

1. Align the wall plug with the casing located on the transformer.

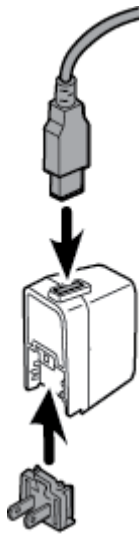

2. Slide the wall plug onto the transformer until it is firmly seated.
3. Insert the USB connector.
4. Insert the other end of the USB into the device.
5. Plug the transformer into an AC outlet.

Charge the device

Charge the ProBP 3400 with the Welch Allyn-supplied power supply.

To charge the device:

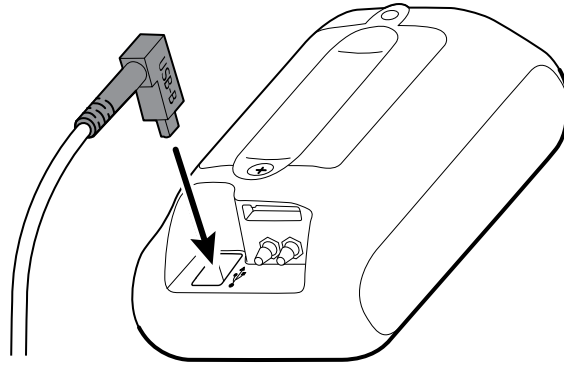

1. Insert the USB B connector into the USB/external power connection port on the back of the device.
2. Insert the other end of the USB cord into the USB port on the power transformer.
3. Plug the power transformer into an AC outlet.

Setup

Before first-time use of the ProBP 3400, complete the following steps:

Insert the battery

The battery is shipped separately from the ProBP 3400 device. You must install and charge the battery for six hours before the device can be used.

1. Remove the screw from the battery compartment door with a Phillips screwdriver.
2. Remove the battery compartment door.
3. Remove the battery from the shipping bag.
4. Using the polarized guidelines on the battery label, insert the battery, positive (+) side first, into the battery compartment.
5. Replace the battery compartment door.
6. Secure the screw with the screwdriver.

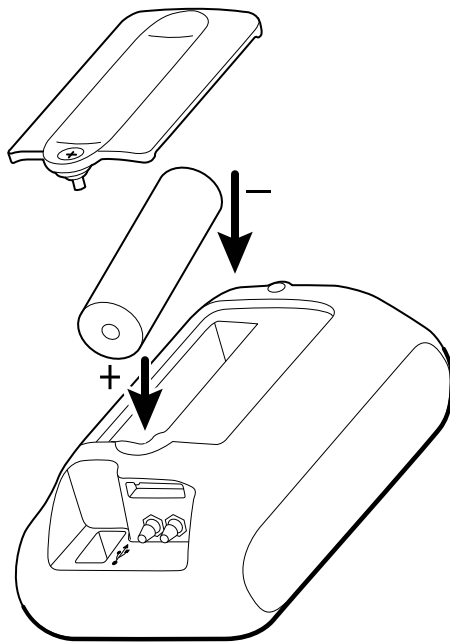

Assemble power cord and wall plug/line cord assembly

1. Align the grooves on the casting of the power transformer with the two-prong wall plug, or for the mobile stand configuration align the adapter with the power transformer casing and connect the line cord assembly.
2. Slide the wall plug or adapter/line cord assembly onto the transformer until it is firmly seated.

Charge the ProBP 3400

To charge the device:

1. Insert the USB B connector into the USB/external power connection port on the back of the device.
2. Insert the other end of the USB cord into the USB port on the power transformer, then plug the transformer into the an AC outlet.

Mount the device

For mounting instructions, see the accessory's directions for use.

For mounting options, see the ProBP 3400 approved accessories in the Appendix.

Initial startup

To complete initial configuration, you must turn on the device, and select an operating language, date, and time.

1. Press the **Power on/power off** button. After device power up, the display window shows the Language screen.
2. Use the Up and Down navigation buttons to highlight the correct option.
3. Press the **Select** button to choose a language. A confirmation window displays your language selection.

Set date and date format

After you select a language, set the device Date and Date format:

1. The Date format field is highlighted. Press the **Up navigation** or **Down navigation** buttons to access the correct format option.
2. Press the **Select** button to accept the date format as shown.
3. Press the **Down navigation** button to highlight the date.
4. Press the **Select** button. The first numeric field is highlighted for editing.
5. Use the **Up navigation** button to increase the number value; use the **Down navigation** button to decrease the number value.
6. Press the **Right navigation** button to move to the next field.
7. Repeat steps 5 and 6 to edit additional numeric values.
8. Press the **Right navigation** button to highlight the **OK** button.
9. Press the **Select** button to accept the date as shown.
10. Press the **Down navigation** button to highlight the **Next** button.
11. Press the **Select** button to move to the Time and Time format screen.

Set time and time format

1. The Time format field is highlighted. Press the **Up navigation** or **Down navigation** buttons to access the correct format option.
2. Press the **Select** button to accept the time format as shown.
3. Press the **Down navigation** button to highlight the time.
4. Press the **Select** button. The first numeric field is highlighted for editing.
5. Use the **Up navigation** button to increase the number value; use the **Down navigation** button to decrease the number value.
6. Press the **Right navigation** button to move to the next field.
7. Repeat steps 5 and 6 to edit additional numeric values.
8. Press the **Right navigation** button to highlight the **OK** button.

9. Press the **Select** button to accept the entry.
10. Press the **Down navigation** button to highlight the **Next** button.
11. Press the **Select** button to complete the Setup process. The device will display the Home screen.

Battery



WARNING Defective batteries can damage the device. If the battery shows any signs of damage, leakage, or cracking, it must be replaced immediately, and only with a battery recommended for or supplied with the device.



WARNING Improper disposal of batteries may create an explosion or contamination hazard. Never dispose of batteries in refuse containers. Do not dispose of the battery in fire. Always recycle batteries according to local regulations.



WARNING Improper handling of the battery can lead to heat generation, smoke, bursting, or fire.



WARNING Do not remove the label from the battery.



WARNING Do not disassemble, modify, or solder the battery.



WARNING Do not directly connect or short circuit the positive (+) and negative (-) battery terminals.



WARNING To avoid short circuits, keep battery terminals away from metal objects.



WARNING Do not expose the battery to temperatures higher than 80 °C /176 °F.



WARNING Electric shock hazard. Do not open the device or attempt repairs. There are no user-serviceable parts inside ProBP 3400 other than battery replacement. Only perform routine cleaning and maintenance procedures specifically described in this instructions for use. Inspection and servicing of internal parts shall only be performed by qualified service personnel.

The ProBP 3400 device is powered by a lithium-ion rechargeable battery.



The battery is shipped separately from the ProBP 3400 device. You must install and charge the battery for six hours before using the device.

To install the battery:

1. Remove the screw from the battery compartment door with a Phillips screwdriver.
2. Remove the battery compartment door.
3. Remove the battery from the shipping bag.
4. Using the polarized guidelines on the battery label, insert the battery, positive (+) side first, into the battery compartment.

5. Replace the battery compartment door.
6. Secure the screw with the screwdriver.

The battery charges when the ProBP 3400 is connected to an external power source. While the

ProBP 3400 is charging, the  symbol displays an amber indicator and the battery charging indicator, , displays on the Home screen. The battery charging indicator is only visible when

the device is powered on. When the battery is charged, the  symbol displays a green indicator, and the battery level indicator is steady with all segments continuously shown on the Home screen. An operator can use the device while the battery is charging; however, the battery charges faster when the instrument is not in operation.

A dead battery may result if the ProBP 3400 is left uncharged or unused for a long period of a time. If this occurs, charge the battery by connecting the ProBP 3400 to an external power source. Charge the battery for at least six hours before disconnecting the device from the power supply.

If the ProBP 3400 will be unused for several months or longer, remove the battery prior to storing the device.

Startup

Press the **Power on/power off** button to turn the device on or off. Upon each power up, the display lights up and the ProBP 3400 displays the model number. When the internal self-check completes, the display shows the Home screen with all values blank, and the device is ready for operation.

The ProBP 3400 powers off when not in use for 2 minutes, whether on battery power or plugged into an external power supply.

If a system error is detected, the device displays a system fault message that contains a wrench icon  and a system fault code to assist service and engineers in diagnosing the problem.

User adjustable settings

The following default time-out settings are user adjustable by USB connecting the ProBP 3400 to a PC running the Welch Allyn Service Tool (WAST).

- Display Blank Timeout while connected to external power
- Device Sleep Timeout while connect to external power
- Display Blank Timeout while running on battery power
- Device Sleep Timeout while running on battery power

The WAST software is available for free download at <https://www.hillrom.com/en/services/welch-allyn-service-tool/>.

Blood pressure procedure

Blood pressure measurement



WARNING Patient injury risk and inaccurate measurement risk. Do not place the cuff where it can disturb proper circulation. Do not place the cuff on any area where circulation is compromised or on any extremity used for intravenous infusions.



WARNING Patient injury risk. The blood pressure cuff must be properly positioned to ensure blood pressure accuracy and patient safety. Wrapping the cuff too loosely (preventing proper inflation) may result in inaccurate NIBP readings.



WARNING Patient injury risk. Do not allow a blood pressure cuff to remain on the patient more than 3 minutes when inflated above 15 mmHg. Excessive cuff tightness may cause venous congestion, peripheral nerve injury, discoloration of the limb, and patient distress.



WARNING Patient injury risk. ProBP 3400 is not intended to measure blood pressure on neonatal patients. The AAMI SP10:2002 standard defines neonates as children 28 days or less of age if born at term (37 weeks gestation or more); otherwise up to 44 gestational weeks.



WARNING Patient injury risk. This device is not intended for use on neonates, infants, or children under the age of 3 years. The effectiveness of this device has not been established in pregnant, including pre-eclamptic, patients.

The preferred blood pressure measurement site for adults and children is the upper arm. Keep the patient's arm relaxed and motion-free during measurement(s). The patient should be seated and relaxed for 5 minutes prior to the blood pressure measurement. The patient should also be comfortably seated, legs uncrossed, feet flat on the floor, back and arm supported. The middle of the cuff should be at the level of the heart. The patient should not talk during the measurement.

Obtain blood pressure measurement

Patient position:

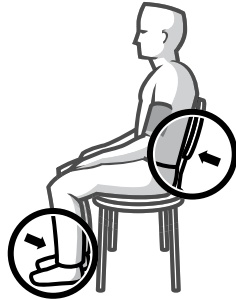

Recommended operator position:

1. Stand in front of the device within 1 meter.
2. Face the device with the monitor at an angle that allows you to easily view the screen.

To initiate blood pressure measurements:

1. Press the **Power on/power off** button to turn the device on.
2. Properly size the blood pressure cuff and position it around the patient's bare upper arm with the artery index marker over the brachial artery. Leave room between the cuff and the arm for no more than two fingers.
3. From the Home screen, press the **Blood Pressure Start/Stop** button.

The ProBP 3400 inflates the blood pressure cuff to the appropriate pressure and displays the pressure as the blood pressure cuff is deflating.

If your device contains the SureBP feature (captures blood pressure on inflation): From the Home screen, press the **Blood Pressure Start/Stop** button. The ProBP 3400 inflates the cuff to the appropriate level, measuring the blood pressure as the cuff is inflating. The systolic display shows the pressure in the cuff as the blood pressure determination is in process. If the device is unable to determine a blood pressure while the cuff is inflating due to patient movement, excessive noise, or an arrhythmia, the device will use the Step algorithm to inflate the cuff to a higher pressure, then attempt to measure the blood pressure while deflating the cuff.

Pressing the **Blood Pressure Start/Stop** button at any time during a blood pressure determination aborts the measurement and rapidly deflates the cuff.

When complete, the ProBP 3400 device displays systolic, diastolic, pulse rate measurements, and if enabled, MAP calculation.

Settings

1. From the Home screen, press the **Right navigation** button. Settings is highlighted.
2. Press the **Select** button. The Settings menu displays.
3. Use **Up** or **Down navigation** buttons to highlight the Unit of measure, Pressure preset, *Bluetooth*radio, or Advanced menus.



NOTE The *Bluetooth* radio menu option is only visible for devices that contain the *Bluetooth* licensed feature. The NIBP algorithm is only visible for devices that contain the SureBP licensed feature.

Settings matrix

Settings >	Unit of measure
	Pressure presets
	<i>Bluetooth</i> radio
	Advanced >
	Cycle count
	Data management
	Date
	Time
	MAP
	NIBP algorithm
	Language

Unit of measure

To select a unit of measure:

1. From the Settings screen, use **Up** or **Down navigation** buttons to highlight Unit of measure.
2. Press the **Select** button. The Unit of measure menu displays.
3. Use **Up** or **Down navigation** buttons to highlight mmHg or kPa.

4. Press the **Select** button to select the unit of measure.

The default unit of measure is mmHg.

Pressure presets

To select a pressure preset:

1. From the Settings screen, use **Up** or **Down navigation** buttons to highlight Pressure presets.
2. Press the **Select** button. The Pressure presets menu displays.
3. Use **Up** or **Down navigation** buttons to highlight desired pressure.
4. Press the **Select** button to select the pressure.

The default inflation pressure is 160 mmHg or 21.3 kPa.

Bluetooth wireless technology

To wirelessly transfer data from the ProBP 3400 to another device with *Bluetooth* technology, you must enable *Bluetooth* technology in both devices, then pair and connect the devices. Pairing will create a unique wireless link between two *Bluetooth* wireless technology enabled devices.

The default setting for *Bluetooth* radio is Enable.

Enable *Bluetooth* radio and pair devices

When trying to pair the ProBP 3400 with a target device, keep the devices within several meters or feet of each other.

To enable the *Bluetooth* radio and pair your *Bluetooth* wireless technology-enabled devices:

1. From the Settings screen, use **Up** or **Down navigation** buttons to highlight **Bluetooth radio**.
2. Press the **Select** button.
3. Use the **Up** or **Down navigation** buttons to highlight **Enable**.
4. Press the **Select** button to confirm your selection.
5. Press the **Down navigation** button to highlight the **Pair** button.
6. Press the **Select** button to place the ProBP 3400 into Pairing mode.
7. Activate the *Bluetooth* feature on your target device and search for the ProBP 3400.

Consult your target device's user manual for device-specific instructions.

8. Select the ProBP 3400 from the list of devices found by your target device.
9. Enter the PIN (**1234**) to pair the ProBP 3400 to your target device.

The ProBP 3400 supports the Secure Simple Pairing feature, which allows the device to be paired to a target device without requesting a PIN. This feature is available for target devices that are compliant with *Bluetooth* version 2.1 or higher.

10. When pairing is complete, the ProBP 3400 will automatically connect to your target device and will attempt to reconnect to your target device each time the ProBP 3400 is powered on.

When devices are connected, the  symbol appears in the left corner of the ProBP 3400 screen.

Connect the ProBP 3400 to a target device

When the ProBP 3400 is paired to a target device, it will attempt to automatically reconnect each time you turn on the ProBP 3400. If the devices do not connect within 60 seconds of turning on the ProBP 3400, the *Bluetooth* radio will shut down to conserve battery power.

If the ProBP 3400 does not automatically reconnect,

1. Press the **Power on/power off** button to turn the device off.
2. Ensure that you are within several meters or feet of the target device.
3. Press the **Power on/power off** button to turn the device on.

Advanced settings

To view or modify advanced settings:

1. From the Settings screen, press the **Up** or **Down navigation** buttons to highlight the Advanced menu.
2. Press the **Select** button. The Advanced menu displays.
3. Use **Up** or **Down navigation** buttons to highlight the Cycle count, Data management, Date, Time, MAP or Language screens.

Cycle count

To view device cycle count:

1. From the Advanced screen, use **Up** or **Down navigation** buttons to highlight Cycle count.
2. Press the **Select** button. The total number of readings taken on the device displays.
3. Use the **Down navigation** button to highlight Close.

Data management

The ProBP 3400 is able to store up to 50 readings in its internal memory. The Data management function allows you to manage how additional readings are stored.

1. From the Advanced screen, use **Up** or **Down navigation** buttons to highlight Data management.
2. Press the **Select** button.
3. Use the **Up** or **Down navigation** buttons to highlight Auto overwrite or Ask overwrite.

If Auto overwrite is selected, the device will overwrite previous readings, starting with Reading 1, once internal memory is full. If Ask overwrite is selected, the user will have to confirm the save of each additional reading once the memory is full.

4. Press the **Select** button to confirm your choice.

The default data management setting is Auto overwrite.

Select date

To modify the date shown on the Home screen:

1. From the Advanced screen, use **Up** or **Down navigation** buttons to highlight Date.
2. Press the **Select** button to edit the entry.
3. The Date format field is highlighted. Press the **Up navigation** or **Down navigation** buttons to access the correct format option.
4. Press the **Select** button to accept the date format as shown.
5. Press the **Down navigation** button to highlight the date.
6. Press the **Select** button. The first numeric field is highlighted for editing.
7. Use the **Up navigation** button to increase the number value; use the **Down navigation** button to decrease the number value.
8. Press the **Right navigation** button to move to the next field.
9. Repeat steps 7 and 8 to edit additional numeric values.
10. Press the **Right navigation** button to highlight the **OK** button.
11. Press the **Select** button to accept the entry.

Select time

To modify the time shown on the Home screen:

1. From the Advanced screen, use **Up** or **Down navigation** buttons to highlight Time.
2. Press the **Select** button to edit the entry.
3. The Time format field is highlighted. Press the **Up navigation** or **Down navigation** buttons to access the correct format option.
4. Press the **Select** button to accept the time format as shown.
5. Press the **Down navigation** button to highlight the time.
6. Press the **Select** button. The first numeric field is highlighted for editing.
7. Use the **Up navigation** button to increase the number value; use the **Down navigation** button to decrease the number value.
8. Press the **Right navigation** button to move to the next field.
9. Repeat steps 7 and 8 to edit additional numeric values.
10. Press the **Right navigation** button to highlight the **OK** button.
11. Press the **Select** button to accept the entry.

MAP

1. From the Advanced screen, use **Up** or **Down navigation** buttons to highlight MAP.
2. Press the **Select** button.
3. Use the **Up** or **Down navigation** button to highlight On or Off.
4. Press the **Select** button to confirm your choice.

The default MAP setting is On.

Language

To change device language:

1. From the Advanced screen, use **Up** or **Down navigation** buttons to highlight Language.
2. Press the **Select** button. The Language screen displays.
3. Use the **Up** or **Down navigation** buttons to highlight the correct Language option.
4. Press the **Select** button to choose a language.

A popup confirmation screen will display your language selection.

The default language is English.

Data review

Data is accessed through the Review menu. Data can be identified by number, date, time reading was taken, diastolic/systolic parameters, MAP, and pulse rate data captured at the time of the reading.

Review data

1. From the Home screen, press the **Left navigation** button. The Review menu option is highlighted.
2. Press the **Select** button. Review menu displays.
3. Use **Up** or **Down navigation** buttons to review the desired reading.

Delete data

1. From the Home screen, press the **Left navigation** arrow. The Review menu option is highlighted.
2. Press the **Select** button. Blood pressure, pulse rate, MAP data (if enabled), date, and time displays.
3. Use **Up** or **Down navigation** buttons to highlight desired reading.
4. Press the **Select** button to delete selected reading. A popup confirmation screen will appear; use **Up** or **Down navigation** buttons to highlight deletion of the selected reading, deletion of all readings, or to exit the screen without saving changes.
5. Press the **Select** button to confirm deletion of selected or all readings or press the **Blood Pressure Start/Stop** button to exit without saving your changes.

Maintenance and service

Inspection

Routinely inspect the ProBP 3400 and accessories for wear, fraying, or other damage. Do not use if you see signs of damage, if the device malfunctions, appears not to be working properly, or if you notice a change in performance. Contact Hillrom's Technical Support department for assistance.

Calibrate the device

Welch Allyn recommends annual calibration of the ProBP 3400.

To calibrate the ProBP 3400,

- Use the Welch Allyn Service Tool. <https://www.hillrom.com/en/services/welch-allyn-service-tool/>
- Send the device to a Hillrom service center near you. For service and product assistance, please contact Hillrom Technical Support: [hillrom.com/en-us/about-us/locations/](https://www.hillrom.com/en-us/about-us/locations/)

Change the battery



WARNING Defective batteries can damage the device. If the battery shows any signs of damage, leakage, or cracking, it must be replaced immediately, and only with a battery recommended for or supplied with the device.



WARNING Improper disposal of batteries may create an explosion or contamination hazard. Never dispose of batteries in refuse containers. Do not dispose of the battery in fire. Always recycle batteries according to local regulations.



WARNING Improper handling of the battery can lead to heat generation, smoke, bursting, or fire.



WARNING Do not remove the label from the battery.



WARNING Do not disassemble, modify, or solder the battery.



WARNING Do not directly connect or short circuit the positive (+) and negative (-) battery terminals.



WARNING To avoid short circuits, keep battery terminals away from metal objects.



WARNING Do not expose the battery to temperatures higher than 80 °C/176 °F.



WARNING Electric shock hazard. Do not open the device or attempt repairs. There are no user-serviceable parts inside ProBP 3400 other than battery replacement. Only perform routine cleaning and maintenance procedures specifically described in this directions for use. Inspection and servicing of internal parts shall only be performed by qualified service personnel.

The ProBP 3400 device is powered by a lithium-ion rechargeable battery.

To remove the battery:

1. Remove the screw from the battery compartment door with a Phillips screwdriver.
2. Remove the battery compartment door.
3. Remove the battery from the battery compartment.
4. Remove the new battery from the shipping bag.
5. Using the polarized guidelines on the battery label, insert the battery, positive (+) side first, into the battery compartment.
6. Replace the battery compartment door.
7. Secure the screw with the screwdriver.

If the ProBP 3400 will be unused for a long period of time, remove the battery prior to storing the device.

Clean the device



WARNING Electric shock hazard. Before cleaning the device, disconnect the power cord from the power source and the device. Ensure that the power transformer and wall plug assembly are dry before plugging into an outlet.



WARNING Take care to prevent water or other fluid from entering any connectors on the device, power transformer and wall plug. Should this occur, dry the connectors with warm air. Check the accuracy of all operating functions.



CAUTION The device is not heat-resistant. Do not autoclave.

The following agents are compatible with the device:

- 70 percent isopropyl alcohol
- 10 percent chlorine bleach/90 percent water solution



NOTE Clean the device on a routine basis, according to your facility's protocols and standards or local regulations

70 percent isopropyl alcohol

Wipe the device with a clean cloth slightly dampened with 70 percent isopropyl alcohol.

10 percent chlorine bleach/90 percent water solution

1. Wipe the device with a clean cloth slightly dampened with a 10 percent bleach and 90 percent water solution.
2. Rinse with a clean cloth slightly dampened with clean water.
3. Allow the device surface to dry for a minimum of 10 minutes before using the device.

Clean the accessories

Wipe the NIBP hose and any reusable cuffs with a damp cloth moistened in a mild detergent solution.

The same cleaning agents used to clean the device can be used on the stand and mounting accessories.



WARNING Electric Shock Hazard. If you clean the power transformer, take the following precautions:

- Ensure the power transformer is unplugged from the outlet.
- Ensure that the cleaning cloth is not dripping or over saturated.
- Apply minimal pressure on the wipe or cloth when cleaning; avoid wiping the gap or connection areas on the power transformer and wall plug.
- Ensure the power transformer, wall plug, and cord are dry before plugging into an outlet.

Specifications

Physical specifications

Performance

This section describe normal ranges for the ProBP 3400 device.

Blood Pressure Accuracy

Blood pressure accuracy meets or exceeds ANSI.AAMI SP10:2002 standards for noninvasive blood pressure accuracy (± 5 mmHg mean error, 8 mmHg standard deviation). Blood pressure accuracy is validated for pressure measurement using the upper arm only.

Cuff pressure range	0 to 300 mmHg
Systolic range	60 to 250 mmHg
Diastolic range	30 to 160 mmHg
Mean Arterial Pressure (MAP) range	40 to 190 mmHg
MAP is a calculated reading that yields an approximate value.	
Pulse rate range	35 to 199 bpm
Pulse rate accuracy	$\pm 5.0\%$
Overpressure cutoff	300 mmHg

Mechanical specifications

Dimensions	Height: 15.0 cm (5.91 inches)
	Width: 8.0 cm (3.15 inches)
	Depth: 5.6 cm (2.20 inches)
Weight	450 g (0.99 lb)
Mounting	Custom mobile stand
	Custom wall mount

Portability	Custom desk mount May be used as a handheld device
-------------	---

Electrical specifications

Power requirements:	Input: 100-240VAC, 0.18A, 50-60Hz Output: 5VDC, 0.5A
Degree of protection:	Type BF applied part
Safety classification:	Class II
Internally powered:	Proprietary 3.6V lithium-ion battery
Protection against the ingress of water:	IPX0
Safety mode of operation:	Continuous operation
Standards:	This device complies with the following standards: EN/IEC 60601-1 EN/IEC 60601-1-2 EN/IEC 80601-2-30 This device was clinically investigated to the requirements of ISO 81060-2:2013 IEC 62304 EN 1060-1:1996 Specification for non-invasive sphygmomanometers - Part 1: General requirements EN 1060-3:1997 Specification for non-invasive sphygmomanometers - Part 3: Supplementary requirements for electro-mechanical blood pressure measuring systems FCC Subpart 15C FCC ID #PI4411B, IC 1931B-BTM411

Environmental specifications



WARNING Fire and explosion hazard. Do not operate the device in the presence of a flammable anesthetic mixture with air, oxygen, or nitrous oxide; in oxygen-enriched environments; or in any other potentially explosive environment.



CAUTION Use the device within stated operating temperature ranges. The device will not meet performance specifications if used outside these temperatures ranges.

Operating temperature	10°C to 40° C (50° to 104° F)
Storage temperature	-20°C to 50° C (-4° to 122° F)

Operating altitude	-170 to 4877 m (-557 to 16,000 ft.)
Operating humidity	15 to 90%
Storage altitude	-170 to 4877 m (-557 to 16,000 ft.)
Storage humidity	15 to 95% (noncondensing)

Product disposal

Customers must adhere to all federal, state, regional, and/or local laws and regulations as pertains to the safe disposal of medical devices and accessories. If in doubt, the user of the device shall first contact Hillrom Technical Support for guidance on safe disposal protocols.

Standards and compliance

General safety compliance

The device complies with the following standards:

IEC 60601-1, IEC 60601-1-2, IEC 60601-1-6, IEC 62366, IEC 80601-2-30, ISO 81060-1, ISO 10993-1. The device has been clinically investigated to the requirements of ISO 81060-2. Radio compliance is maintained and includes FCC ID (P14411B) and IC (1931B-BTM411). Country-specific standards are included in the applicable Declaration of Conformity.

General radio compliance

The *Bluetooth* Wireless Card must be used in strict accordance with the manufacturer's instructions as described in the user documentation that comes with the product.

This device complies with Part 15 of the FCC rules and with the rules of the Canadian ICES-003. Operation is subject to the following two conditions: (1) This device may not cause harmful interference and (2) this device must accept any interference received, including interference that may cause undesired operation.

Federal Communications Commission (FCC)

This device complies with part 15 of the FCC Rules. Operation is subject to the following two conditions:

- This device may not cause harmful interference.
- This device must accept any interference received, including interference that may cause undesired operation.

This equipment has been tested and found to comply with the limits for a Class B digital device, pursuant to Part 15 of FCC Rules. These limits are designed to provide reasonable protection against harmful interference in a residential installation. This equipment generates, uses, and can radiate radio frequency energy. If not installed and used in accordance with the instructions, it may cause harmful interference to radio communications. However, there is no guarantee that interference will not occur in a particular installation. If this equipment does cause harmful interference to radio or television reception, which can be determined by turning the equipment off and on, the user is encouraged to try and correct the interference by one or more of the following measures:

- Reorient or relocate the receiving antenna
- Increase the distance between the equipment and the receiver

- Connect the equipment to an outlet on a circuit different from that to which the receiver is connected
- Consult the dealer or an experienced radio/TV technician for help

The user may find the following booklet prepared by the Federal Communications Commission helpful:

The Interference Handbook

This booklet is available from the U.S. Government Printing Office, Washington, D.C. 20402. Stock No. 004-000-0034504.

Welch Allyn is not responsible for any radio or television interference caused by unauthorized modification of the devices included with this Welch Allyn product, or the substitution or attachment of connecting cables and equipment other than specified by Welch Allyn.

The correction of interference caused by such unauthorized modification, substitution, or attachment will be the responsibility of the user.

Industry Canada (IC)

This device complies with RSS 210 of Industry Canada.

Operation is subject to the following two conditions: (1) this device may not cause interference, and (2) this device must accept any interference, including interference that may cause undesired operation of this device.

L'utilisation de ce dispositif est autorisée seulement aux conditions suivantes: (1) il ne doit pas produire de brouillage et (2) l'utilisateur du dispositif doit être prêt à accepter tout brouillage radioélectrique reçu, même si ce brouillage est susceptible de compromettre le fonctionnement du dispositif.

This Class B digital apparatus complies with Canadian ICES-003.

Cet appareil numérique de la classe B est conforme à la norme NMB-003 du Canada.

European Union

The *Bluetooth* radio contained within this equipment complies with the essential requirements of the EU Radio Equipment Directive (2014/53/EU).

Guidance and manufacturer's declaration

EMC compliance

Special precautions concerning electromagnetic compatibility (EMC) must be taken for all medical electrical equipment. This device complies with IEC 60601-1-2:2014.

- All medical electrical equipment must be installed and put into service in accordance with the EMC information provided in this *Instructions for use*.
- Portable and mobile RF communications equipment can affect the behavior of medical electrical equipment.

The monitor complies with all applicable and required standards for electromagnetic interference.

- It does not normally affect nearby equipment and devices.
- It is not normally affected by nearby equipment and devices.
- It is not safe to operate the monitor in the presence of high-frequency surgical equipment.
- However, it is good practice to avoid using the monitor in extremely close proximity to other equipment.



NOTE The ProBP 3400 has essential performance requirements associated with blood pressure measurement. In the presence of EM disturbances, the device might display an error code. Once the EM disturbances stop, the ProBP 3400 will self-recover and perform as intended.



WARNING Avoid using the ProBP 3400 adjacent to or stacked with other equipment or medical electrical systems because it could result in improper operation. If such use is necessary, observe the ProBP 3400 and other equipment to verify that they are operating normally.



WARNING Use only accessories recommended by Welch Allyn for use with the ProBP 3400. Accessories not recommended by Welch Allyn might affect the EMC emissions or immunity.



WARNING Maintain minimum separation distance between the ProBP 3400 and portable RF communication equipment. ProBP 3400 performance might degrade if you do not maintain a proper distance between equipment.



WARNING This device has not been tested for use in clinical environments near high-frequency surgical equipment and magnetic resonance imaging. Do not use this device in environments like these where electromagnetic disturbance is high.

Emissions and immunity information

Electromagnetic emissions

The device is intended for use in the electromagnetic environment specified below. The customer or user of the device should assure that it is used in such an environment.

Emissions test	Compliance	Electromagnetic environment - guidance
RF emissions CISPR 11	Group 1	The device uses RF energy only for its internal function. Therefore, its RF emissions are very low and are not likely to cause any interference in nearby electronic equipment.
RF emissions CISPR 11	Class B	The device is suitable for use in all establishments other than domestic establishments and those directly connected to the public low-voltage power supply network that supplies buildings used for domestic purposes, provided the following warning is heeded:
Harmonic emissions IEC 61000-3-2	Class A	
Voltage fluctuations/ flicker emissions IEC 61000-3-3	Complies	 <p>WARNING This equipment/system is intended for use by healthcare professionals only. This equipment/ system may cause radio interference or may disrupt the operation of nearby equipment^a. It may be necessary to take mitigation measures, such as re-orienting or relocating the device or shielding the location.</p>

^a The device contains a 5-GHz orthogonal frequency-division multiplexing transmitter or a 2.4-GHz frequency hopping spread-spectrum transmitter for the purpose of wireless communication. The radio is operated according to the requirements of various agencies, including FCC 47 CFR 15.247 and RED Directive (2015/53/EU). The transmitter is excluded from the EMC requirements of 60601-1-2, but should be considered when addressing possible interference issues between this and other devices.

EIRP (Equivalent Isotropically Radiated Power): 0.4 dBm

ISM (Industrial, Scientific, and Medical) band: 2.4 – 2.485 GHz

Electromagnetic immunity

The device is intended for use in the electromagnetic environment specified below. The customer or the user of the device should assure that it is used in such an environment.

Immunity test	IEC 60601 test level	Compliance level	Electromagnetic environment - guidance
Electrostatic discharge (ESD) IEC 61000-4-2	±8 kV contact	± 8 kV	Floors should be wood, concrete or ceramic tile. If floors are covered with synthetic material, the relative humidity should be at least 30%.
	± 15 kV air	± 15 kV	
Electrical fast transient/burst IEC 61000-4-4	±2 kV for power supply lines	±2 kV	Mains power quality should be that of a typical commercial or hospital environment.
	±1 kV for input/output lines	±1 kV	
Surge IEC 61000-4-5	± 0.5 kV, ± 1 kV Line-to-line	± 1 kV	Mains power quality should be that of a typical commercial or hospital environment.
	± 0.5 kV, ± 1 kV, ± 2 kV Line-to-ground	± 2 kV	
Voltage dips, short interruptions and voltage variations on power supply input lines IEC 61000-4-11	0% U_T ; 0.5 cycle At 0°, 45°, 90°, 135°, 180°, 225°, 270° and 315°	0% U_T ; 0.5 cycle	Mains power quality should be that of a typical commercial or hospital environment. If the user of the monitor requires continued operation during power mains interruptions, it is recommended that the monitor be powered from an uninterruptible power supply or a battery.
	0% U_T ; 1 cycle and 70% U_T ; 25/30 cycles	0% U_T ; 1 cycle and 70% U_T ; 25/30 cycles	
	0% U_T ; 300 cycle Single phase: at 0°	0% U_T ; 300 cycle	
Power frequency (50/60 Hz) magnetic field IEC 61000-4-8	30 A/m	30 A/m	Power frequency magnetic fields should be at levels characteristic of a typical location in a typical commercial or hospital environment.

Note U_T is the AC mains voltage prior to application of the test level.

Electromagnetic immunity

The monitor is intended for use in the electromagnetic environment specified below. The customer or the user of the monitor should assure that it is used in such an environment.

Immunity test	IEC 60601 test level	Compliance level	Electromagnetic environment - guidance
Recommended separation distance			
Conducted RF IEC 61000-4-6	3 Vrms 150 kHz to 80 MHz	3 Vrms	$d = \left[\frac{3.5}{V_1} \right] \sqrt{P}$
	6 Vrms in ISM and amateur radio bands between 150 kHz and 80 MHz	6 Vrms	$d = \left[\frac{12}{V_2} \right] \sqrt{P}$
Radiated RF IEC 61000-4-3	10 V/M 80 MHz to 2.7 GHz	10 V/M	$d = \left[\frac{12}{E_1} \right] \sqrt{P}$
			80 MHz to 800 MHz $d = \left[\frac{23}{E_1} \right] \sqrt{P}$ 800 MHz to 2.7 GHz where P is the maximum output power rating of the transmitter in watts (W) and d is the recommended separation distance in meters (m). Field strengths from fixed RF transmitters, as determined by an electromagnetic site survey ^a , should be less than the compliance level in each frequency range ^b . Interference may occur in the vicinity of equipment marked with the following symbol:



Note 1 At 80 MHz and 800 MHz, the higher frequency range applies.

Note 2 These guidelines may not apply in all situations. Electromagnetic propagation is affected by absorption and reflection from structures, objects, and people.

^aField strengths from fixed transmitters, such as base stations for radio (cellular/cordless) telephones and land mobile radios, amateur radio, AM and FM radio broadcast, and TV broadcast cannot be predicted theoretically with accuracy. To assess the electromagnetic environment due to fixed RF transmitters, an electromagnetic site survey should be considered. If the measured field strength in the location in which the monitor is used

Electromagnetic immunity

exceeds the applicable RF compliance level above, the monitor should be observed to verify normal operation. If abnormal performance is observed, additional measures may be necessary, such as reorienting or relocating the monitor.

^bOver the frequency range 150 kHz to 80 MHz, field strengths should be less than 10 V/m.

Recommended separation distances between portable and mobile RF communications equipment and the monitor

The monitor is intended for use in an electromagnetic environment in which radiated RF disturbances are controlled. The customer or user of the monitor can help prevent electromagnetic interference by maintaining a minimum distance between portable and mobile RF communications equipment (transmitters) and the monitor as recommended below, according to the maximum output power of the communications equipment.

Separation distance according to frequency of transmitter (m)				
Rated max. output power of transmitter (W)	150 kHz to 80 MHz outside ISM bands	150 kHz to 80 MHz in ISM bands	80 MHz to 800 MHz	800 MHz to 2.7 GHz
	$d = [\frac{3.5}{V_1}] \sqrt{P}$	$d = [\frac{12}{V_2}] \sqrt{P}$	$d = [\frac{12}{E_1}] \sqrt{P}$	$d = [\frac{23}{E_1}] \sqrt{P}$
0.01	0.12	0.20	0.12	0.23
0.1	0.37	0.63	0.38	0.73
1	1.17	2.00	1.20	2.30
10	3.69	6.32	3.79	7.27
100	11.67	20.00	12.00	23.00

For transmitters rated at a maximum output power not listed above, the recommended separation distance d in meters (m) can be estimated using the equation applicable to the frequency of the transmitter, where P is the maximum output power rating of the transmitter in watts (W) according to the transmitter manufacturer.

Note 1: At 80 MHz and 800 MHz, the separation distance for the higher frequency range applies.

Note 2: These guidelines may not apply in all situations. Electromagnetic propagation is affected by absorption and reflection from structures, objects, and people.

Test specifications for enclosure port immunity to RF wireless communications equipment

Test frequency (MHz)	Band ^a (MHz)	Service ^a	Modulation ^b	Maximum power (W)	Distance (m)	Immunity test level (V/m)
385	380 - 390	TETRA 400	Pulse modulation ^b 18 Hz	1.8	0.3	27
450	430 - 470	GMRS 460, FRS 460	FM ^c ±5 kHz deviation 1 kHz sine	2	0.3	28
710 745 780	704 - 787	LTE band 13, 17	Pulse modulation ^b 217 Hz	0.2	0.3	9
810 870 930	800 - 960	GSM 800/900, TETRA 800, iDEN 820, CDMA 850, LTE Band 5	Pulse modulation ^b 18 Hz	2	0.3	28
1720 1845 1970	1700 - 1990	GSM 1800; CDMA 1900; GSM 1900; DECT; LTE Band 1, 3, 4, 25; UMTS	Pulse modulation ^b 217 Hz	2	0.3	28
2450	2400 - 2570	Bluetooth, WLAN, 802.11 b/g/n, RFID 2450, LTE Band 7	Pulse modulation ^b 217 Hz	2	0.3	28
5240 5500 5785	5100 - 5800	WLAN 802.11 a/n	Pulse modulation ^b 217 Hz	0.2	0.3	9

NOTE If necessary to achieve the IMMUNITY TEST LEVEL, the distance between the transmitting antenna and the monitor may be reduced to 1 m. The 1 m test distance is permitted by IEC 61000-4-3.

^a For some services, only the uplink frequencies are included.

^b The carrier shall be modulated using a 50 percent duty cycle square wave signal.

^c As an alternative to FM modulation, 50 percent pulse modulation at 18 Hz may be used because while it does not represent actual modulation, it would be worst case.

Warranty

Welch Allyn will warranty the ProBP 3400 device and battery to be free of defects in material and workmanship and to perform in accordance with manufacturer specifications for the period of one year from the date of purchase from Welch Allyn or its authorized distributors or agents.

The warranty period shall start on the date of purchase. The date of purchase is: 1) the invoiced ship date if the device was purchased directly from Welch Allyn, 2) the date specified during product registration, 3) the date of purchase of the product from a Welch Allyn authorized distributor as documented from a receipt from said distributor.

This warranty does not cover damage caused by: 1) handling during shipping, 2) use or maintenance contrary to labeled instructions, 3) alteration or repair by anyone not authorized by Welch Allyn, and 4) accidents.

The product warranty is also subject to the following terms and limitations:

Accessories are not covered by the warranty. Refer to the Directions For Use provided with individual accessories for warranty information.

Shipping cost to return a device to a Welch Allyn Service center is not included.

A service notification number must be obtained from Welch Allyn prior to returning any products or accessories to Welch Allyn's designated service centers for repair. To obtain a service notification number, contact Welch Allyn Technical Support.

THIS WARRANTY IS IN LIEU OF ALL OTHER WARRANTIES, EXPRESS OR IMPLIED, INCLUDING BUT NOT LIMITED TO THE IMPLIED WARRANTIES OF MERCHANTABILITY AND FITNESS FOR A PARTICULAR PURPOSE. WELCH ALLYN'S OBLIGATION UNDER THIS WARRANTY IS LIMITED TO REPAIR OR REPLACEMENT OF PRODUCTS CONTAINING A DEFECT. WELCH ALLYN IS NOT RESPONSIBLE FOR ANY INDIRECT OR CONSEQUENTIAL DAMAGES RESULTING FROM A PRODUCT DEFECT COVERED BY THE WARRANTY.

Troubleshooting

Inaccurate blood pressure readings

Possible cause	Corrective action and explanation
Incorrect cuff size	Use Welch Allyn approved cuffs only. Measure patient's arm circumference midway between elbow and shoulder (see "Blood pressure cuff selection" to select correct cuff size).
Patient's arm position	Ensure patient's arm is at heart level.
Arm movement during blood pressure cycle	Keep arm still during blood pressure cycle. Movement may cause inaccuracies from artifact.
Blood pressure taken over clothing	Take blood pressure on a bare arm.
Arrhythmia	Check for regularity of heart rate (palpate pulse or check device). Moderate to severe heart rate irregularities may make blood pressure difficult to measure accurately.
Change in blood pressure between auscultatory reading and ProBP 3400 reading	Check blood pressure immediately before ProBP 3400 reading. Blood pressure is dynamic and changing. It is normal for blood pressure to fluctuate 5 to 10 mmHg.
Incorrect reference	Use the correct Korotkoff sound to determine diastolic blood pressure. <ul style="list-style-type: none"> Many listeners incorrectly equate diastolic blood pressure with the disappearance of sound only (phase 5). ProBP 3400 was developed using the American Heart Association recommendations, which state that phase 5 be used unless sound continues to 0 mmHg, in which case the change in the quality of sound (phase 4) is to be used. Deflate cuff no faster than 3 mmHg per second. <ul style="list-style-type: none"> One of the major sources of error in auscultatory blood pressure measurement is deflating the cuff

Possible cause	Corrective action and explanation
	<p>too quickly. The American Heart Association recommends deflation no faster than 3 mmHg per second.</p> <p>Only use a sphygmomanometer that is calibrated.</p> <ul style="list-style-type: none"> An uncalibrated sphygmomanometer may result in inaccurate blood pressure measurements.
Poor auscultatory sound recognition by observer	Use high-quality stethoscope. Have a different observer check patient's blood pressure.

Cuff inflation and deflation with no blood pressure reading displayed

Possible cause	Corrective action and explanation
Leak in pneumatic system	<p>Inflation too quick; check NIBP cuff and tubing connections may display.</p> <p>Cuff pressure limits exceeded. Powering down may display.</p> <p>NIBP air leak; check cuff and tubing connections may display.</p> <p>Unable to determine NIBP; check inflation settings may display.</p> <p>Ensure all cuff attachments are tight.</p> <p>Carefully check for leaks in the blood pressure cuff, tubing, and pressure hose attached to ProBP 3400.</p>
Patient's measured blood pressure is outside the rated specification limits of the device	Determined blood pressure is outside of the rated range. Evaluate the patient using manual methods.
Arm movement during cycle	<p>Unable to determine NIBP; check connections; limit patient movement may display.</p> <p>Keep arm still during blood pressure cycle.</p> <p>Movement may cause inaccuracies from artifact, long cycle times, and error message.</p>
Cuff tubing or pressure hose movement artifact	<p>Unable to determine NIBP; check connections and tubing for kinks may display.</p> <p>Do not contact cuff tubing or pressure hose during blood pressure cycle.</p> <p>Movement may cause inaccuracies from artifact.</p>
User may have pressed the Blood Pressure Start/Stop button	User cancelled NIBP reading will display. Press the Blood Pressure Start/Stop button to initiate blood pressure measurement.

No cuff inflation

Possible cause	Corrective action and explanation
Connections between device and cuff loose	Check all connections.
Device is being used in inclimate environment	Ambient temperature is outside of operating range. Retry measurement may display. Operate the device within temperature range in the Environmental specifications section.
Internal errors or messaging error occurred	NIBP feature not functional. Call for service may display. Contact a Welch Allyn Service Center.

Cuff pops off

Possible cause	Corrective action and explanation
Inappropriate cuff size	See "Blood pressure cuff selection" to select correct cuff size. If cuff continues to pop off, notify biomedical department or Welch Allyn Technical Support.
Cuff not applied securely	Smooth hook and loop securely before inflating cuff.
Cuff applied inside out	Re-apply cuff. Verify that the Welch Allyn label is facing away from arm.

Cuff deflating too slowly

Possible cause	Corrective action and explanation
Patient movement	Have patient sit still. Do not have arm tight against chest wall, as respiration may affect speed and accuracy of blood pressure measurement.
Arrhythmia	Check for regularity of heart rate (palpate pulse or check device). Moderate to severe heart rate irregularities may make blood pressure difficult to measure accurately.
Small leak in pneumatic system	Check cuff tubing and pressure hose for leaks.

Device does not turn on

Possible cause	Corrective action and explanation
Low battery	Plug in the device. Check connections between the ProBP 3400 and the transformer, then between the transformer and wall receptacle.
Battery installed incorrectly	Using the polarized guidelines on the battery label, insert the battery, positive (+) side first, into the battery compartment.
Device not powering up	<p>Unplug the device from wall receptacle and check for breaks in the cord. If connections are secure, check electrical outlet for power. Charging indicator is on if connections are good and the device is plugged into a working outlet.</p> <p>Plug the device into a known working electrical outlet.</p> <p>The device may not power up if the battery is completely discharged. Connect the device to an external power source for at least 15 minutes before attempting to power up again. If device powers up, charge the battery for at least six hours before disconnecting the device from the power supply.</p> <p>Replace the battery.</p> <p>Notify Biomedical department or Welch Allyn Technical Support.</p>
System error	The device displays a system fault message that contains a wrench icon  and a system fault code to assist service and engineers in diagnosing the problem.

Bluetooth troubleshooting

ProBP 3400 and the target device will not pair

Possible cause	Corrective action and explanation
Bluetooth radio is not enabled on the ProBP 3400	See <i>Bluetooth</i> wireless technology section for instructions on enabling <i>Bluetooth</i> functionality in the device.
ProBP 3400 is not in Pairing mode	See <i>Bluetooth</i> wireless technology section for instructions on enabling pairing in the device.
There is too much distance between ProBP 3400 and the target device	Move the ProBP 3400 closer to the target device.

Possible cause	Corrective action and explanation
The wrong PIN was entered for a <i>Bluetooth</i> 2.0 connection	If a PIN is requested, enter 1234 .
There is a problem with the target device	Refer to operating system or computer hardware manuals for further troubleshooting.

ProBP 3400 and the target device are not connected

Possible cause	Corrective action and explanation
ProBP 3400 and the target device have not been paired.	Follow instructions for pairing the ProBP 3400 to a target device. If pairing was attempted: <ul style="list-style-type: none"> • Complete pairing process again • See troubleshooting section for ProBP 3400 and the target device will not pair.
There is too much distance between ProBP 3400 and the target device	Move the ProBP 3400 closer to the target device.
The target device and/or software were not launched in the correct order	The connection process was not completed in the correct order. <ol style="list-style-type: none"> 1. Exit the application on the computer. 2. Power down, then power up ProBP 3400. 3. Relaunch the computer application.
There is a problem with the target device	Refer to operating system or computer hardware manuals for further troubleshooting.

ProBP 3400 and the target device lost connection

Possible cause	Corrective action and explanation
Unexpected loss in <i>Bluetooth</i> communication The ProBP 3400 powered down	<ol style="list-style-type: none"> 1. Exit the target application. 2. Power down the ProBP 3400 3. Restart the ProBP 3400 4. Relaunch the target application.
There is too much distance between ProBP 3400 and the target device	Move the ProBP 3400 closer to the target device.
There is a problem with the target device	Refer to operating system or computer hardware manuals for further troubleshooting.

Appendix

ProBP 3400 approved accessories

Flexiport® cuffs (not made with natural rubber latex)

Part Number	Model	Description
Reuse-08	Reusable	Cuff, reuse, SM CHILD, 2-tube
Reuse-09	Reusable	Cuff, reuse, CHILD, 2-tube
Reuse-10	Reusable	Cuff, reuse, SM AD, 2-tube
Reuse-11	Reusable	Cuff, reuse, ADULT, 2-tube
Reuse-11L	Reusable	Cuff, reuse, AD LONG, 2-tube
Reuse-12	Reusable	Cuff, reuse, LG AD, 2-tube
Reuse-12L	Reusable	Cuff, reuse, LG AD LONG, 2-tube
Reuse-13	Reusable	Cuff, reuse, THIGH, 2-tube

Blood pressure accessories (not made with natural rubber latex)

Part Number	Model	Description
3400-30	ProBP 3400	Double tube blood pressure hose (5 ft)
3400-31	ProBP 3400	Double tube blood pressure hose (10 ft)

Mounting options

Part Number	Description
4600-61-6W	Mobile stand with basket and mounting kit for ProBP 3400

Part Number	Description
4601-61	Wall mount with basket for ProBP 3400
4602-61	Desk mount for ProBP 3400

Accessories and replacement parts

Part Number	Description
BATT11	Lithium Ion battery, 1 Cell
3400-925-6W	ProBP 3400 USB cable, 2.44 m (8 ft)
3400-926-6W	ProBP 3400 USB cable, 0.30 m (16 inches)
4600-100-6W	Power supply mounting kit (for use with mobile stand)
3400-561	ProBP 3400 basket adapter with screw
3400-461	ProBP 3400 wall adapter with screw
PWCD-6WW-B	Power cord assembly, for handheld, or desk or wall mounted ProBP 3400, North America
PWCD-6WT-B	Power cord assembly B, for mobile stand mounted ProBP 3400, North America
PWCD-6WW-2	Power cord assembly 2, for handheld, or desk or wall mounted ProBP 3400, Europe
PWCD-6WT-2	Power cord assembly 2, for mobile stand mounted ProBP 3400, Europe
PWCD-6WW-4	Power cord assembly 4, for handheld, or desk or wall mounted ProBP 3400, United Kingdom
PWCD-6WT-4	Power cord assembly 4, for mobile stand mounted ProBP 3400, United Kingdom
PWCD-6WW-6	Power cord assembly 6, for handheld, or desk or wall mounted ProBP 3400, Australia/New Zealand —Orange
PWCD-6WT-6	Power cord assembly 6, for mobile stand mounted ProBP 3400, Australia/New Zealand —Orange
PWCD-6WW-C	Power cord assembly C, for handheld, or desk or wall mounted ProBP 3400, China
PWCD-6WT-C	Power cord assembly C, for mobile stand mounted ProBP 3400, China
PWCD-6WW-7	Power cord assembly 7, for handheld, or desk or wall mounted ProBP 3400, South Africa
PWCD-6WT-7	Power cord assembly 7, for mobile stand mounted ProBP 3400, South Africa

Part Number	Description
PWCD-6WT-J	Power cord assembly N, for mobile stand mounted ProBP 3400, Japan
3400-100	Battery door

Service

Part Number	Description
S1-3400	Comprehensive Partner Program, ProBP 3400, 1 year
S2-3400	Biomed Partner Program, ProBP 3400, 1 year
S4-3400	Preventive Partner Program, ProBP 3400, 1 year

Licensed features

Part Number	Description
3400-SUREBP	SureBP activation code
3400-BT	<i>Bluetooth</i> activation code

Configuration options

Model	Description
34XFHT-B*	Includes Welch Allyn SureBP® technology, rechargeable lithium-ion battery, size 11 and size 12 FlexiPort® cuffs, handheld configuration
34XFWT-B*	Includes Welch Allyn SureBP® technology, rechargeable lithium-ion battery, size 11 and size 12 FlexiPort® cuffs, wall mounted configuration
34XFST-B*	Includes Welch Allyn SureBP® technology, rechargeable lithium-ion battery, size 11 and size 12 FlexiPort® cuffs, mobile stand mounted configuration
34XXHT-B*	Includes rechargeable lithium-ion battery, size 11 and size 12 FlexiPort® cuffs, handheld configuration
34XXWT-B*	Includes rechargeable lithium-ion battery, size 11 and size 12 FlexiPort® cuffs, wall mounted configuration
34XXST-B*	Includes rechargeable lithium-ion battery, size 11 and size 12 FlexiPort® cuffs, mobile stand mounted configuration

*Replace final digit in model number with regional code listed in the table below.

Accessories and replacement parts

Code	Region
6	Australia/New Zealand - Orange
C	China
2	Europe
J	Japan (mobile stand version only)
B	North America
7	South Africa
4	United Kingdom

