

Instructions for Use

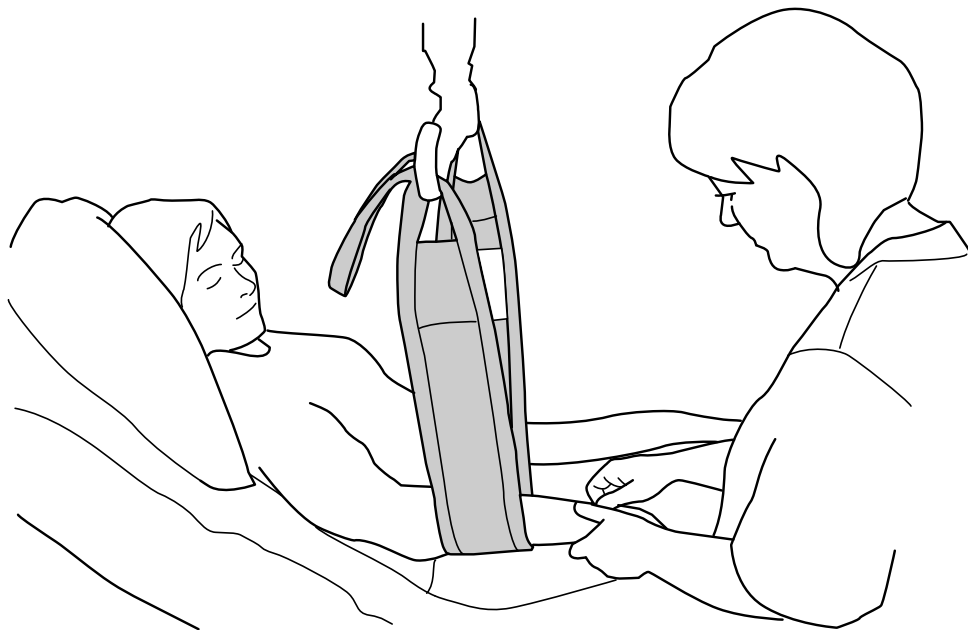

Product Description

The Solo MultiStraps are specially developed for versatile applications in healthcare. The MultiStraps are used for lifting and holding parts of the patient's body to facilitate examination, care and treatment. The MultiStraps can also be used for turning a patient in bed and supporting the patient in a lateral position. Instead of performing these tasks manually, the nursing staff should use the MultiStraps together with a lift and thereby potentially avoid heavy and harmful strains.

Suitable application areas are for:

- Treatment of wounds, e.g. burns
- Hygiene
- Treatment, e.g. catheterization
- Examination
- Positioning of bedpan
- Dressing/undressing
- Turning sideways.

The MultiStraps can be used alone or in pairs, e.g. for lifting both legs of the patient during catheterization.

The MultiStraps are available in different models/widths. The narrower MultiStraps are often easier to place and give better access to a larger skin area. Choose a wider MultiStrap for larger support area and pressure distribution.

The MultiStraps are available in two materials, polyester and non-woven, both with pressure-equalizing reinforced pads. The Solo MultiStrap in the non-woven design is intended for short-term use and should be discarded when the product is soiled or when the patient no longer needs it. For more information about MultiStrap in polyester, please contact your Hill-Rom representative.

The MultiStraps can be used together with Liko's mobile or overhead lifts.

⚠ The MultiStraps are not intended for lifting and moving a patient from one location to another. For these applications we recommend lifting with one of the Liko slings available in many models.















In this document, the person being lifted is referred to as the patient and the person helping is referred to as the caregiver.

IMPORTANT!

Lifting and transferring a patient always involves a certain level of risk. Read the instructions for use for both the patient lift and lifting accessories before use. It is important to completely understand the contents of the instructions for use. The equipment should only be used by trained personnel. Ensure that the lifting accessories are suitable for the lift used. Exercise care and caution during use. As a caregiver, you are always responsible for the patient's safety. You must be aware of the patient's ability to make it through the lifting situation. If something is unclear, contact the manufacturer or supplier.

Symbol Description

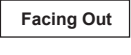
These symbols can be found in this document and/or on the product.

Symbol	Description
	Warning. Used where extra care and attention is needed.
	Read instructions for use before use
	CE mark
	Legal manufacturer
	Date of manufacturing
	Ref number
	Serial Number
	Medical device
	Do not wash
	Latex Free
	Do not use Product (Only Solo products and visible after wash when use is prohibited).
	Direction upwards and symbol on outside of product
	Symbol on outside of product.
 <small>(01) 0100887761997127 (11) YYMMDD (21) 012345678910</small>	GS1 Data Matrix Barcode that may contain following information. (01) Global Trade Item Number (11) Production Date (21) Serial Number

Safety Instructions

Before lifting, keep the following points in mind:

- Choose the MultiStrap best suited to the task at hand.
- Pay attention to any skin sensitivity, pressure sensitivity or pain in those places where the MultiStraps are to be applied.
- Ensure that the patient has the joint mobility necessary to passively lift body parts with the MultiStraps.
- Before lifting limb, plan the lifting operation to make it as safe and convenient as possible.
- Although the Liko sling bars are equipped with safety latches, special caution must be exercised. Before the limb is lifted from the bed, but after the straps are fully extended, make sure the strap loops are properly attached to the sling bar.
- Never leave a patient unattended during a lifting situation.
- The wheels of the bed must be locked during a lifting/transfer operation; this is especially important when turning patients.
- Use bed rails during the turning operation; this is especially important when only one caregiver is performing the task.
- Plan the lifting operation so that it can be done as safely and smoothly as possible.
- Always work ergonomically.



Registered Design

Product Changes

Liko's products undergo continuous development, which is why we reserve the right to make product changes without prior notice. Contact your Hill-Rom representative for advice and information about product upgrades.

Design and Quality by Liko in Sweden

Liko is quality-certified in accordance with ISO 9001 and its equivalence for the medical device industry, ISO 13485. Liko is also certified in accordance with environmental standard ISO 14001.

Notice to Users and/or Patients in EU

Any serious incident that has occurred in relation to the device, should be reported to the manufacturer and the competent authority of the Member State in which the user and/or patient is established.

Care and Inspection

Check the MultiStrap before each use. Check the following points with regard to wear and damage:

- Fabric
- Straps
- Seams
- Strap loops

 **Do not use damaged lifting accessories.**

If anything is unclear, please contact the manufacturer or supplier.



DO NOT WASH. On the back of the MultiStrap (applies to Solo MultiStrap Standard and Solo MultiStrap Wide) is a label with this symbol. If the MultiStrap is washed, this label disintegrates to display the symbol DO NOT USE. The MultiStrap must then be disposed of.



Expected Life Time

 Solo MultiStrap is a disposable item, intended for individual use.

The Solo MultiStrap should no longer be used:

- if it is soiled or if it is suspected of being contaminated
- if it is damaged
- when the patient no longer requires it.

Recycling Instructions

The entire product should be sorted as Combustible waste.

Hill-Rom evaluates and provides guidance to its users on the safe handling and disposal of its devices to aid in the prevention of injury, including, but not limited to: cuts, punctures of the skin, abrasions, and any required cleaning and disinfection of the medical device after use and prior to its disposal. Customers should adhere to all federal, state, regional, and/or local laws and regulations as it pertains to the safe disposal of medical devices and accessories.

If in doubt, the user of the device shall first contact Hill-Rom Technical Support for guidance on safe disposal protocols.

Definitions

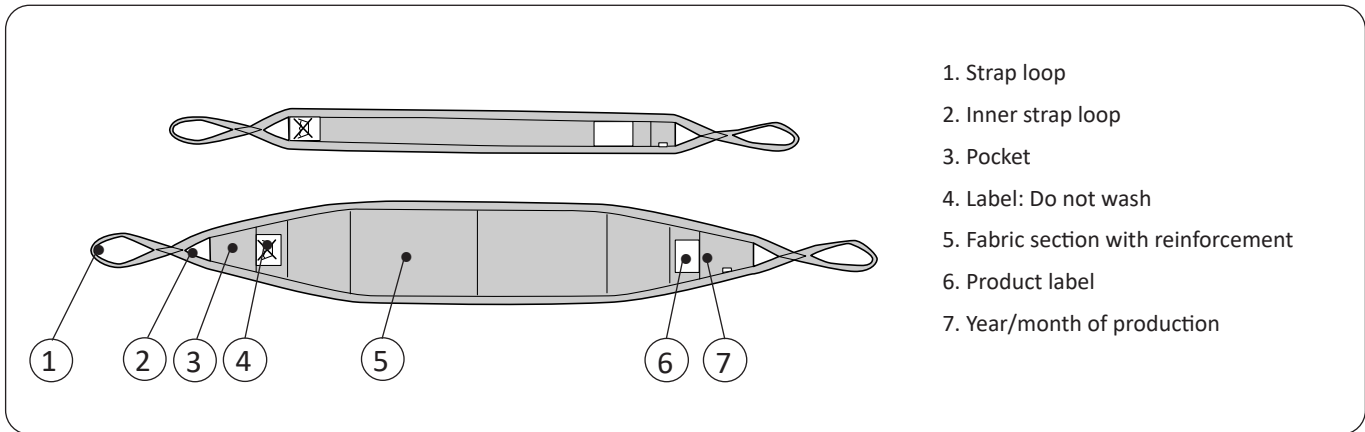

Application

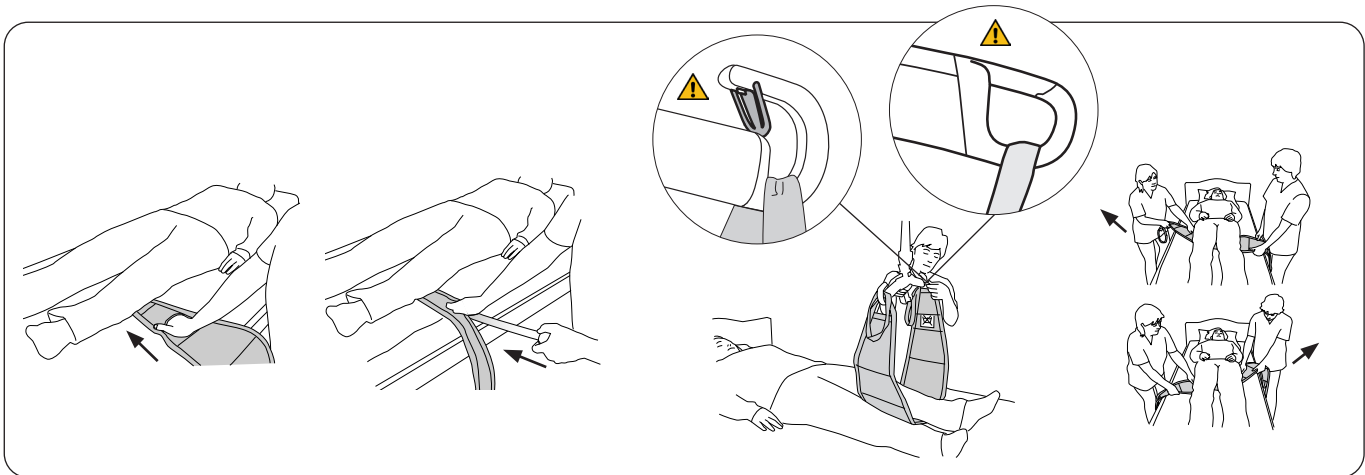

Apply the MultiStrap under the body part which is to be lifted/held. Fold in the strap loop under the MultiStrap and push it in under the patient's body. Insert your hand or use the spatula in the MultiStrap pocket to facilitate the application (please see figures above).

Work out the strap loop from the opposite side and pull the MultiStrap forward so that the body part is placed in the middle of the strap.

Attach the strap loops to the sling bar. Use the inner strap loop if the lifting height is insufficient.

The MultiStrap can also be inserted where there is most space, e.g. under the knees, and then carefully be pulled into place under the patient. This can be made easier by alternatively pulling the MultiStrap from side to side until it is in desired place, for instance under the buttocks.

NOTE: The MultiStrap can also be applied using HandySheet™, which is recommended for heavy patients or when you need to be extra gentle with the patient. For more information please contact your Hill-Rom representative.

Lift and Hold

Place the MultiStrap under the part of the patient's body which is to be lifted/held.
Before lifting, check that the strap loops are properly attached to the sling bar. Lift to desired height.

Example

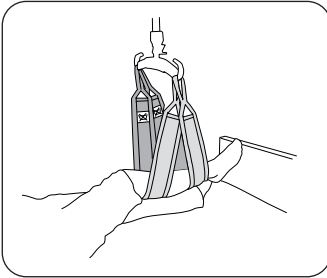

Fig. 1. Lift/hold a leg with two MultiStraps

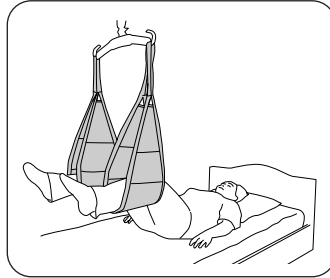

Fig. 2. Lift/hold both legs with two MultiStraps

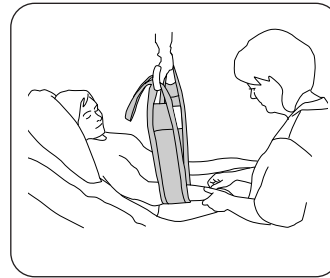

Fig. 3. Lift/hold arm

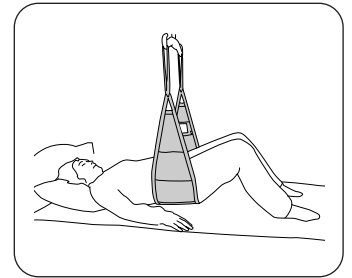
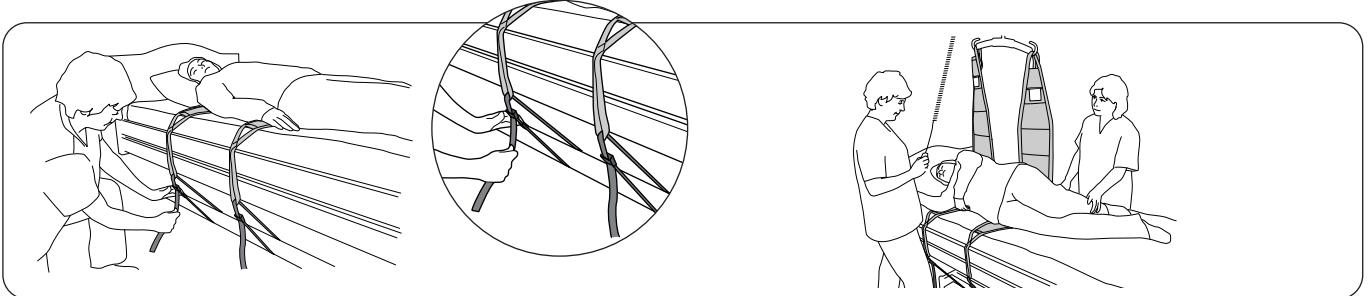

Fig. 4. Lift/hold buttocks

The sling bar with 2-point suspension is recommended for lifting/holding as per the above examples. One MultiStrap (Fig. 3) or two MultiStraps (Fig. 1) can be used.

Turning Sideways

Turning a patient sideways can be done by a lone caregiver, but we recommend two assisting each other. This is a time-effective and smooth way of operating. Use the bed rails, in particular if just one caregiver performs the turning.



Use two MultiStraps; place one under the shoulders and the other under the hips. If necessary, the strap loops can be attached to a suitable place on the bed using FixStraps 135 cm (53 inch.), Prod. No. 3696001. This holds the MultiStraps in place during turning.

Prepare the operation by placing the patient so that the turning is facilitated; one arm out to the side and one leg over the other. Lift in such a manner that the patient is turned sideways by means of the lift. Do not lift so high that there is a risk of the patient tipping over. Adjust the patient's position so that it is comfortable.

⚠ Do not lift too high!

When turning sideways we recommend a sling bar with 2-point suspension.

Removal



Fig. 5.

Fig. 6.

Fold in the strap loop under the MultiStrap (Fig. 5). Work out and grasp the strap loop and remove the MultiStrap carefully (Fig. 6).

The MultiStrap can also be pulled out carefully where there is extra space, e.g. under the knees.

For extra gentle removal, use HandySheet™. For more information please contact your Hill-Rom representative.

Overview Solo MultiStrap™

Name	Width	Prod. No.	Max. Load	Material
Solo MultiStrap Standard	10 cm (3.9 in)	3695915	200 kg	Non-Woven Polypropylene
Solo MultiStrap Wide	25 cm (9.8 in)	3695916	200 kg	Non-Woven Polypropylene

To maintain maximum load, lift/accessories intended for the same load or more are required.

Accessories: Spatula Mod 600 IC (fits MultiStrap Standard and Wide) 3684002
 FixStrap 135 cm (53 inch.) 3696001

Recommended combinations

MultiStrap can be used in combination with the following sling bars:

Sling bar with 2-point suspension: Universal SlingBar 350/450, SlingGuard 450.



www.hillrom.com

Liko AB
 Nedre vägen 100
 975 92 Luleå, Sweden
 +46 (0)920 474700

Liko AB is a subsidiary of Hill-Rom Holdings, Inc.

Enhancing outcomes for
 patients and their caregivers:

