

Liko Ultra LiftPants Mod. 920

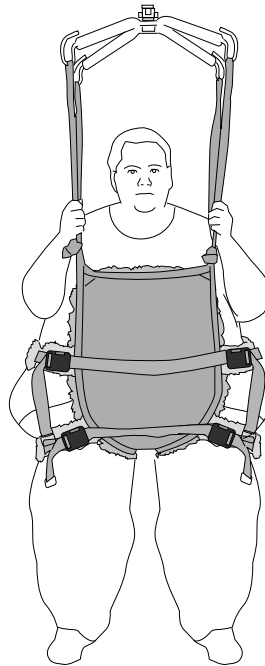

Sling

Instructions for Use



Product Description

Lifting very heavy patients requires special techniques and specially designed lift equipment. Liko has developed the Ultra product series to help lift such patients in a safe and comfortable manner.

Intended Use

The **Liko** Ultra LiftPants sling, when used in accordance with the information for use, gives very heavy patients the chance to practice standing and gait training without the risk of falling. It also can reduce the risk of injuries to caregivers.

The **Liko** Ultra LiftPants are intended for use in the following environments: Health care, Intensive care, Emergency ward, Rehabilitation, Habilitation and Home healthcare environment.

The **Liko** Ultra LiftPants sling aids in safe standing and gait training for patients with poor balance and poor leg function. It is essential that the patient is able to bear weight on their legs. The **Liko** Ultra LiftPants allow the patient to move while relieving them of a greater or lesser degree of body weight.

Sizes

The **Liko** Ultra LiftPants sling is equipped with two hip straps on either side for more even weight distribution. There are two different sizes.

Selecting a suitable lift

It is recommended that at least two caregivers be present when transferring a patient.

The **Liko** Ultra LiftPants sling can be used along with Liko's overhead or mobile lifts. An overhead lift can be used by the patient for unrestricted movement within the lift's lifting area. You can choose between:

- The **Liko** UltraTwin system with two lift units. The maximum load is 500 kg (1100 lbs.), depending on which individual products are included in the assembled lift system. The UltraTwin system is available for both stationary installation and for freestanding installation in the UltraTwin FreeSpan system.
- **LikoGuard** L overhead lift for lifting up to 272 kg (600 lbs.) or **LikoGuard** XL overhead lift for lifting up to 363 kg (800 lbs.).
- **Viking** XL mobile lift for lifting up to 300 kg (660 lbs.). May be equipped with arm rest to give extra support during standing- and gait training.

Alternatives

As an alternative to **Liko** Ultra LiftPants sling, we recommend:

- **Liko** MasterVest Mod. 60 (XXL size).
- **Liko** LiftPants Mod. 92 (XL Size).

In this document, the person being lifted is referred to as the patient and the person helping is referred to as the caregiver.

IMPORTANT!

Lifting and transferring a patient always involves a certain level of risk. Read the instructions for use for both the patient lift and lifting accessories before use. It is important to completely understand the contents of the instructions for use. The equipment should only be used by a trained caregiver. To be trained, a caregiver needs to read and understand the Instructions for Use. Ensure that the lifting accessories are suitable for the lift used. Exercise care and caution during use. As a caregiver, you are always responsible for the patient's safety. You must be aware of the patient's ability to make it through the lifting situation. If something is unclear, contact the manufacturer or supplier.

Table of Contents

Intended Use	1
Safety Information	3
Symbol Description	4
Care and Inspection.....	5
Definitions	5
How to Attach a Sling to Different Sling Bars.....	6
How to Attach an Ultra LiftPants Sling to a Sling Bar with 4 Hooks (Twin Bars and Cross Bars)	7
How to Select Size	7
Dimensions.....	8
Applying the Ultra LiftPants.....	9
Adjusting the Loop Straps.....	10
Removing the Ultra LiftPants.....	11
Optional Components	11
Overview Liko Ultra LiftPants sling Mod. 920.....	12
Recommended Combinations	12

Safety Information

⚠ Before lifting, keep the following points in mind:

- A responsible person within your organization should decide on a case-by-case basis whether one or more caregivers are needed.
- Ensure that the sling selected meets the patient's needs with reference to model, size, fabric and design.
- The total maximum load for a lift system is always determined by the product in the system with the lowest specified maximum load.
- To protect patient safety and hygiene, launder the sling between patients.
- Plan the lifting operation so that it can be done as safely and smoothly as possible.
- Check that the lifting accessory hangs vertically and can move freely.
- Although the Liko sling bars are equipped with latches, special caution must be exercised. Before the patient is lifted from the underlying surface, but when the straps are fully extended, make sure the straps are correctly connected to the sling bar hooks.
- Never lift a patient higher off the underlying surface than is needed to complete the lifting and transfer procedure.
- Make sure that the wheels on the wheelchair, bed, gurney, etc., are locked during the lifting/transfer operation.
- Always work ergonomically. Use the patient's ability to actively participate in the operations.
- When the sling is not being used, do not place in direct sun light.

⚠ Incorrect attachment of sling to sling bar may cause severe injury to the patient.

⚠ Never leave a patient unattended during a lifting situation!

⚠ Never leave children unattended in the vicinity of the sling!

⚠ Do not store the sling where it will be exposed to direct sunlight, or to heat sources, such as a radiator, fireplace, or stove/oven!

⚠ Do not operate, store or transport sling in the vicinity of pets, pests, or unattended children!

⚠ Make sure that the patient and caregiver stay clear of pinch points and moving parts during a lifting event. Injury could occur.

⚠ Evaluate patients for entrapment risk and monitor patients appropriately. Make sure that the patient's head and limbs are not in or between sling loops during lifting event. Failure to do either of these could cause serious injury or death.

⚠ The Ultra LiftPants has not been tested for use in the Magnetic Resonance Imaging (MRI) setting. Transfer the patient to a compatible surface to do an MRI, and remove the sling from the MRI room.

CE Medical Device Class I Product

PATENT www.hillrom.com/patents

May be covered by one or more patents. See above Internet address.

The Hillrom companies are the proprietors of European, US, and other patents and pending patent applications.

Product Changes

Liko's products undergo continuous development, which is why we reserve the right to make product changes without prior notice. Contact your Hillrom representative for advice and information about product upgrades.

Design and Quality by Liko in Sweden

Liko is quality certified according to ISO 9001 and its equivalent for the medical device industry ISO 13485. Liko is also certified according to environmental standard ISO 14001.

Notice to Users and/or Patients in EU

Any serious incident that has occurred in relation to the device, should be reported to the manufacturer and the competent authority of the Member State in which the user and/or patient is established.

Symbol Description

These symbols may be found in this document and/or on the product.

Symbol	Description	Symbol	Description
	Warning; this situation requires extra care and attention. This symbol is a yellow triangle with a black border, and a black exclamation mark at the center.		
	Recyclable		
	Read instructions for use before use. This symbol is a blue circle with a white image of a person reading a book.		
	Read instructions for use before use		Caution! consult instructions for use.
	CE-mark. European Union medical device conformity mark, Class I Medical Device.		
	Swiss authorized representative		
	Legal manufacturer		Date of manufacturing
	Product Identifier		Medical device
	Serial Number		Unique device identification
	Do not dry clean		Line drying in shade
	Do not iron		Do not bleach
	Tumble drying		Do not wash
	Do not tumble dry		
	Washing Symbol is always in combination with recommended temperature in °C and °F.		
	Latex Free		
	Periodic inspection		
	Do not use product (Only on Solo products, and only visible after wash when use is prohibited)		Patient name
	Single patient use (only on Solo products)		
	Direction upwards and symbol on outside of equipment.		Symbol on outside of equipment.
	GS1 Data Matrix Barcode that may contain following information. (01) Global Trade Item Number (11) Production Date (21) Serial Number		

Care and Inspection

Check the sling before each use. Check the following points with regard to wear and damage:

- Fabric
- Straps
- Seams
- Loops
- Buckle

⚠ Do not use damaged lifting accessories.

If anything is unclear, please contact the manufacturer or supplier.

Washing and Disinfection Instructions:

Please see the sling's product label and the attached appendix "Care and Maintenance of Liko Slings".

Material:

The Ultra LiftPants sling is made of 100% polyester.

If the sling is used for bath or shower:

After use in bath and shower situations, the sling should be placed so that it dries as soon as possible.

Periodic Inspection

The product must be inspected at least once every 6 months. More frequent inspections might be required if the product is used or washed more often than normal. For protocols please contact your Hillrom representative.

Expected Life Time

The Ultra LiftPants has an expected life time of 3 years during normal use. Expected life time varies depending on the fabric, use frequency, washing procedure, drying temperature, and weight carried. Hillrom recommends the product be used only during its expected life time.

Recycling Instructions

The entire sling, including laths, padding material, etc. should be sorted as Combustible waste.

Hillrom evaluates and provides guidance to its users on the safe handling and disposal of its devices to aid in the prevention of injury, including, but not limited to: cuts, punctures of the skin, abrasions, and any required cleaning and disinfection of the medical device after use and prior to its disposal. Customers should adhere to all federal, state, regional, and/or local laws and regulations as it pertains to the safe disposal of medical devices and accessories.

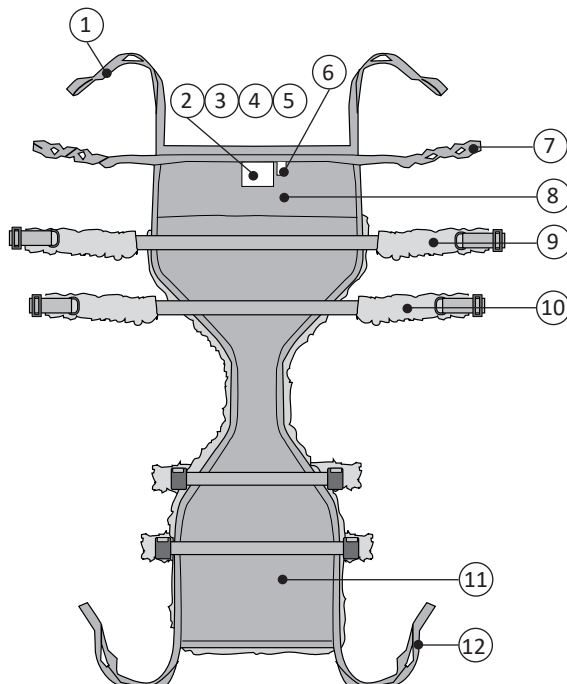

If in doubt, the user of the device shall first contact Hillrom Technical Support for guidance on safe disposal protocols.

Definitions

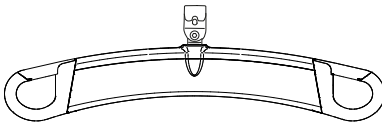
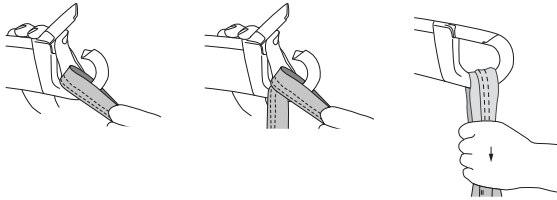
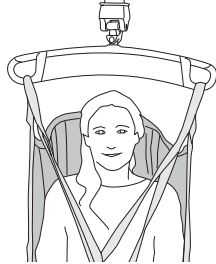
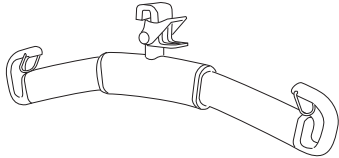
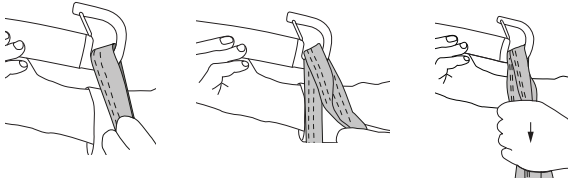

1. Rear suspension straps
2. Product label
3. Serial number
4. Label: Periodic Inspection
5. Label: Individual marking (Belongs to)
6. Size marking (only for size XXL)
7. Loop straps
8. Rear part
9. Upper hip strap
10. Lower hip strap
11. Front part
12. Front suspension strap

How to Attach a Sling to Different Sling Bars

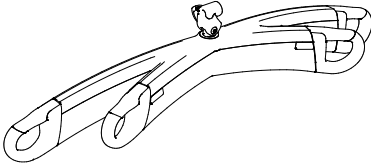
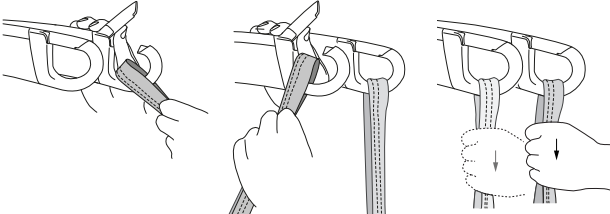
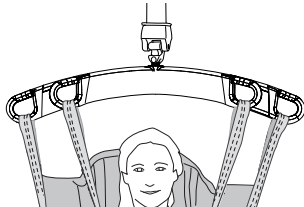
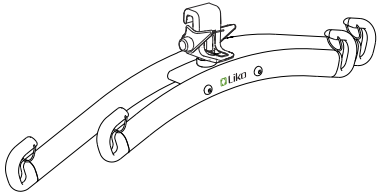
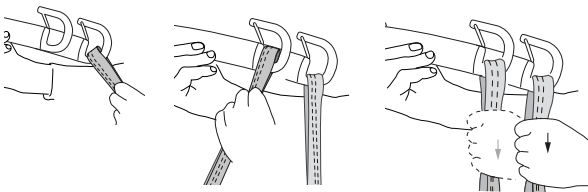
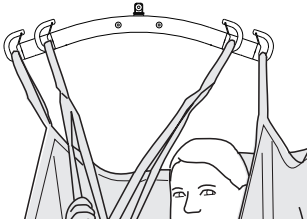
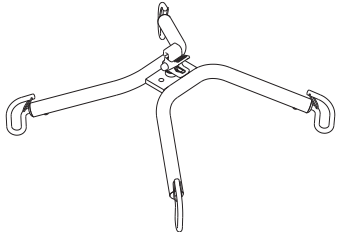
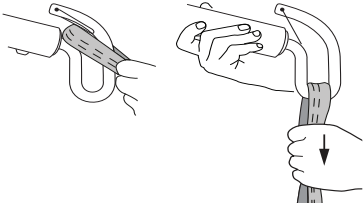
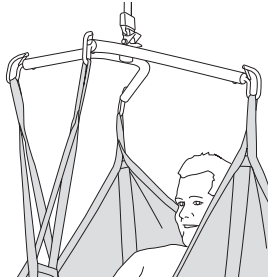
Sling bar	Sling loops to sling bar hooks	Correct
 <p style="text-align: center;">SlingGuard</p>		
 <p style="text-align: center;">Universal SlingBar</p>		
 <p style="text-align: center;">SlingGuard Twin</p>		
 <p style="text-align: center;">Universal Twin</p>		
 <p style="text-align: center;">Cross-bar</p>		

Wrong!

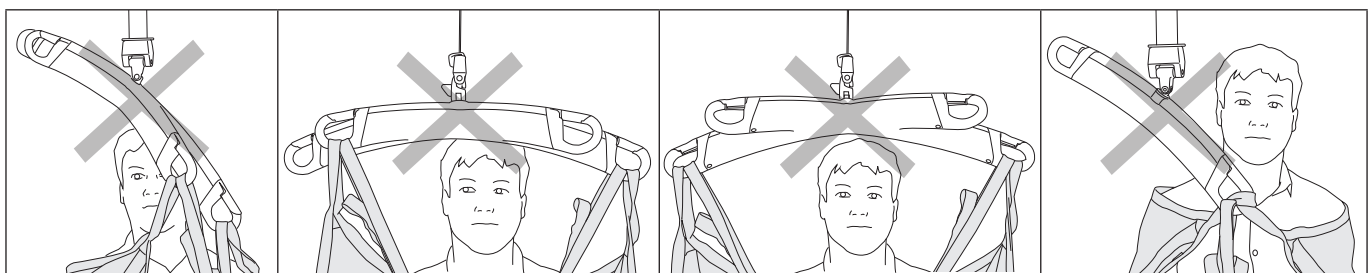

How to Attach an Ultra LiftPants Sling to a Sling Bar with 4 Hooks (Twin Bars and Cross Bars)

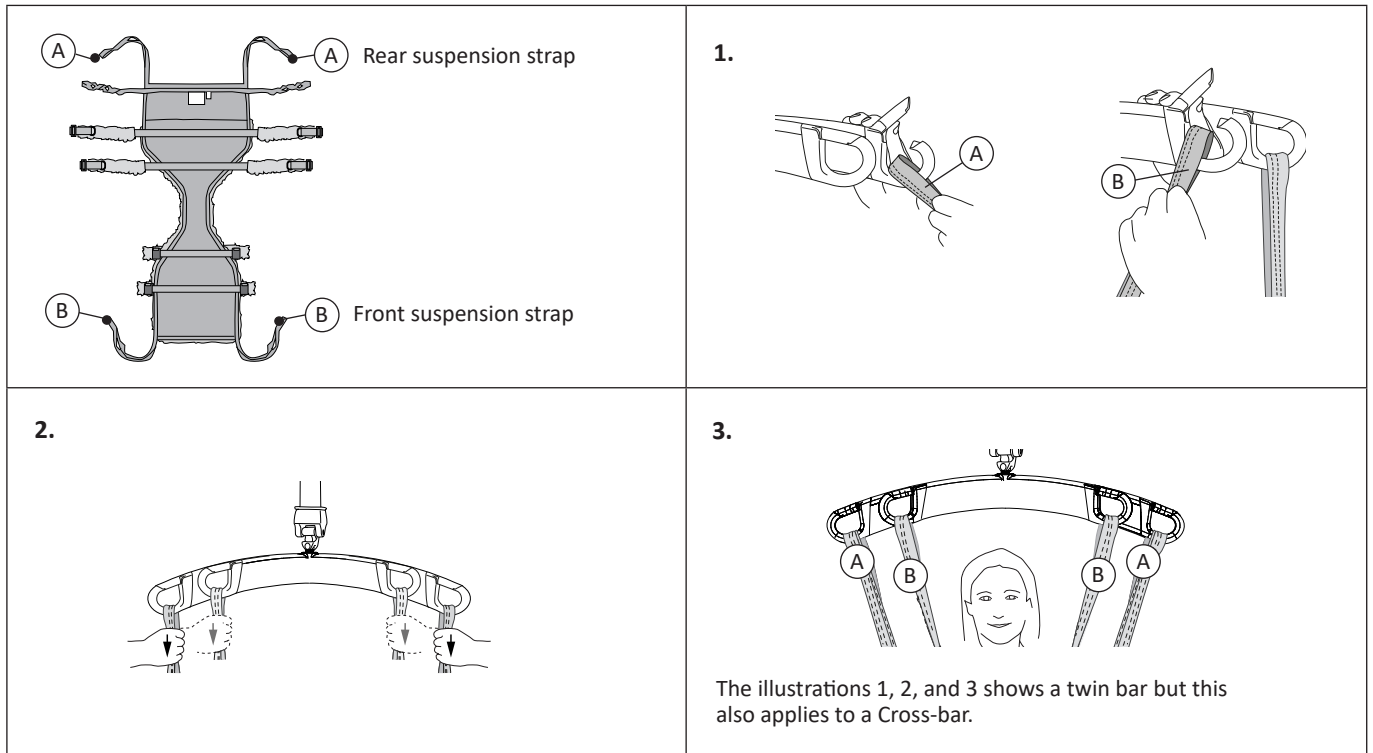

How to Select Size

- ⚠ Do not choose too large size as this can mean that the required lift height cannot be achieved.
- ⚠ Only use a sling that is the correct size for the patient. Correct size must be assessed by a trained caregiver. Patient entrapment or asphyxiation could occur.

Choosing the right size is important for a safe and secure lift and for reaching the required lift height. Liko Ultra LiftPants sling should reach above waist height but not so high that the loop straps cut into the armpits. Measure with a measuring tape from the back of the patient, under the crotch and to above waist level.

Refer to the measurement table below for guidance. Size XXXL has higher fabric sections and longer hip straps in order to reach around a larger belly.

Reference chest circumference on patient and product to “Dimensions” on page 8.

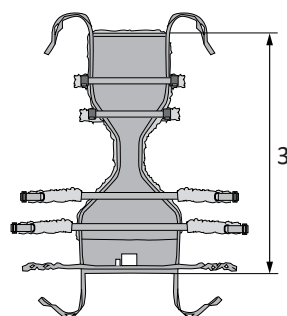
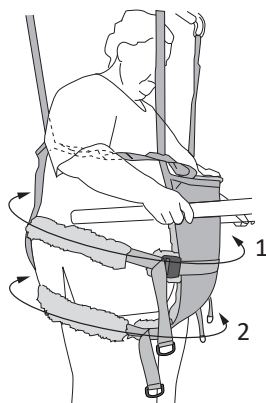

Measure the chest circumference of the patient as follows:

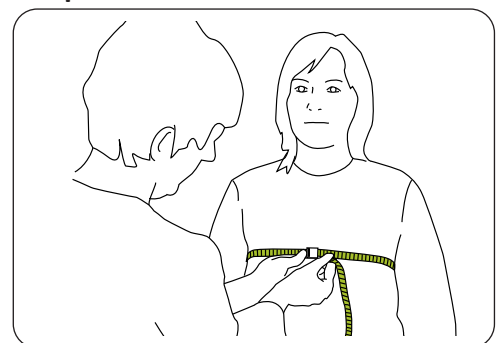

Measure the circumference around the patient's chest (under the bust on women).

Measurement	1	2	3	Chest
XXL	185-260 cm (73-102 in.)	150-210 cm (59-83 in.)	140 cm (55 in.)	128-185 cm (50-73 in.)
XXXL	185-300 cm (73-118 in.)	150-250 cm (59-98 in.)	150 cm (59 in.)	172-222 cm (67-87 in.)

Dimensions

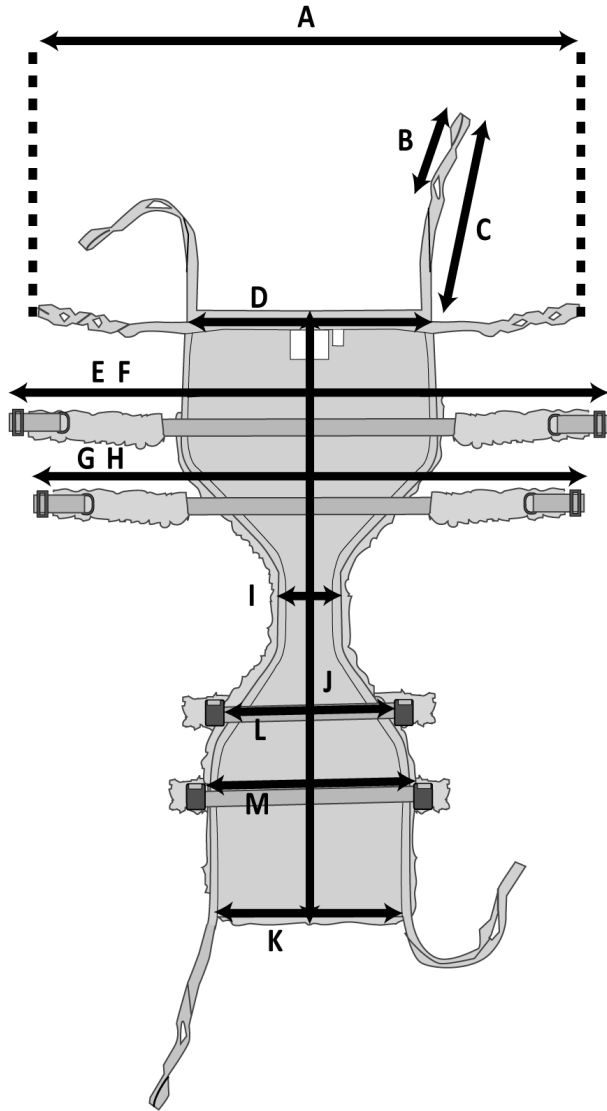

- A: Rear sling loop straps laid flat
- B: Shortening loop length (front and rear)
- C: Suspension strap length (front and rear)
- D: Rear chest breadth
- E: Upper hip strap laid flat (Min value)
- F: Upper hip strap laid flat (Max Value)
- G: Lower hip strap laid flat (Min Value)
- H: Lower hip strap laid flat (Max Value)
- I: Crotch width
- J: Main panel length
- K: Front chest breadth
- L: Front lower hip strap length
- M: Front upper hip strap length

Size Measurements in Centimeters

SIZE	A	B	C	D	E	F	G	H	I	J	K	L	M	Maximum load (kg)	Prod. No.
XXL	147	10	56	60	132	205	110	165	10	140	45	45	54	500	35920328
XXXL	185	10	56	60	132	245	107	205	10	150	45	45	54	500	35920329

Size Measurements in Inches

SIZE	A	B	C	D	E	F	G	H	I	J	K	L	M	Maximum load (lbs)	Prod. No.
XXL	58	4	22	24	52	81	43	65	4	55	18	18	21	1100	35920328
XXXL	73	4	22	24	52	97	42	81	4	59	18	18	21	1100	35920329

Applying the Ultra LiftPants

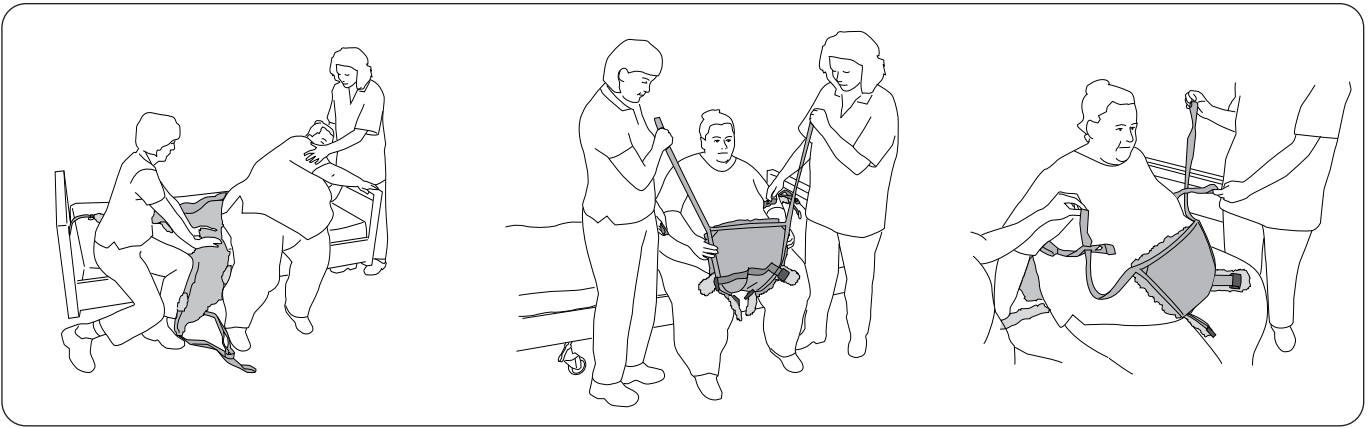

The initial position when using the **Liko Ultra LiftPants** sling is the sitting position. The patient leans to the side so that the Ultra LiftPants sling can be slid into place under the buttocks. Place the Ultra LiftPants sling as far under the patient as possible with the product label facing out from the back. Make sure that the Ultra LiftPants sling is centered and in a good position with as much pant material in back as in front. Adjust as needed.

Pull the front section of the Ultra LiftPants sling up between the legs so that the hip straps are accessible from the front.

Feed the front suspension straps through the loop straps using the appropriate loop (see "Adjusting the Loop Straps" on page 10).

Alternative application of the LIKO Ultra LiftPants sling: The patient can be lifted in a normal sling and then lowered onto the Ultra LiftPants sling placed on a chair or at the edge of the bed. The sling used can be e.g. the **Liko UltraSling Mod. 06**, **Liko Original HighBack Sling Mod. 200** or **Liko Soft Original HighBack Sling Mod. 26**. This application makes it easier if for some reason the patient cannot lean to the side, or if there is no room to apply the Ultra LiftPants sling from the side.

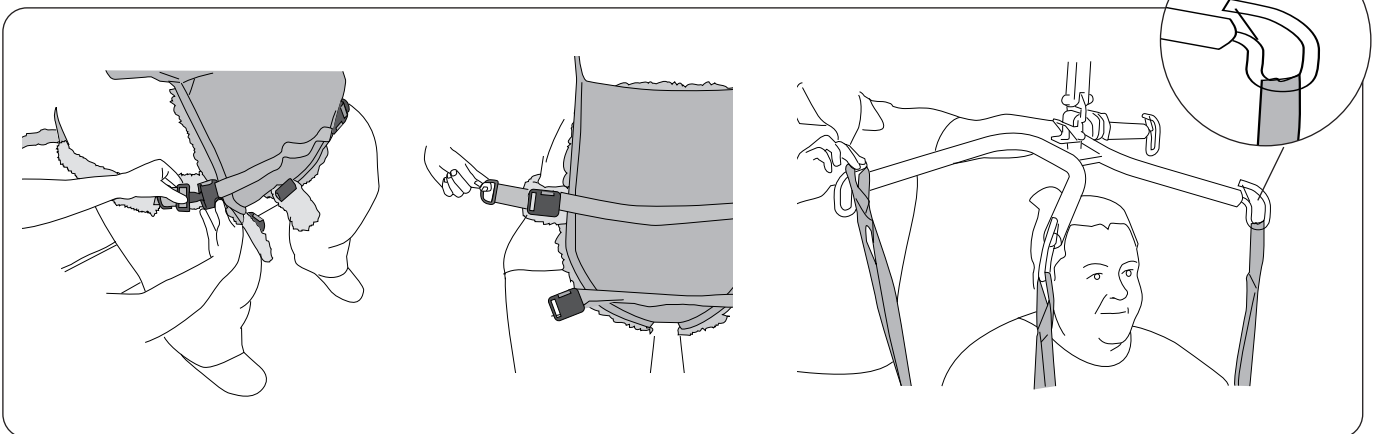

Fasten the hip strap's buckles and pull tight. Depending on the size of the patient, either one or both hip straps may be fastened from the standing position.

⚠ Make sure that the patient and caregiver stay clear of pinch points when the buckles are fastened. Injury could occur.

Connect the rear suspension straps onto the rear hooks on the sling bar, or onto the rear sling bar. Connect the front suspension straps to the front hooks on the sling bar or to the front sling bar. Use the strap loop at the end of the suspension straps. If the patient can not stand under the lift, shorten the straps (see "Shortening position" on page 10). See page 6 and page 7 for instructions on how to attach the sling loops to different sling bars.



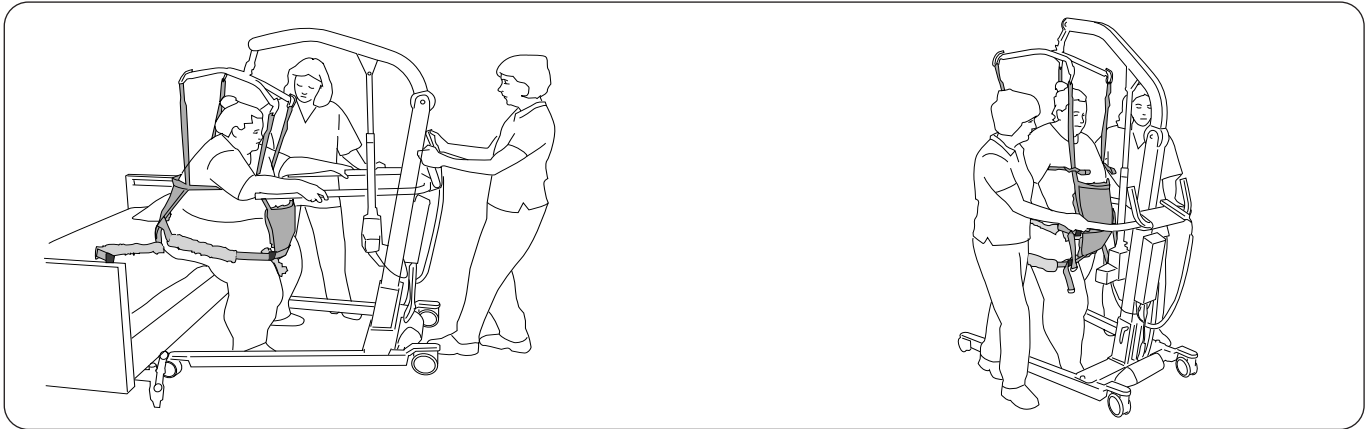

Before assisting the patient to their feet: Make sure that the patient's feet are in a position on the floor where the patient is able to support their weight. This reduces the load on the lift. Run the lift slightly upwards to apply tension to the suspension straps without lifting the buttocks, and make sure that the loop straps are providing adequate support around the patient's upper body.

When the patient has gained their balance standing, the lifting height is adjusted to provide appropriate relief with help from the Ultra LiftPants sling. Gait training can now begin!

During the lifting operation: Pull the lift forward in the direction of movement so that weight transfer takes place properly until the patient is upright and well-balanced.

Shortening position

In certain cases, it is advantageous to shorten the suspension straps for a taller patient to have enough room to stand. The shortening position can be used temporarily in order to test for the right length, yet extended use may damage seams. If you want to shorten the suspension straps for long-term use, it is recommended that you tie a knot in the suspension strap to shorten it about 10 cm (4 inch). Use the loop at the end of the suspension strap to connect the suspension strap to the slingbar.

Adjusting the Loop Straps

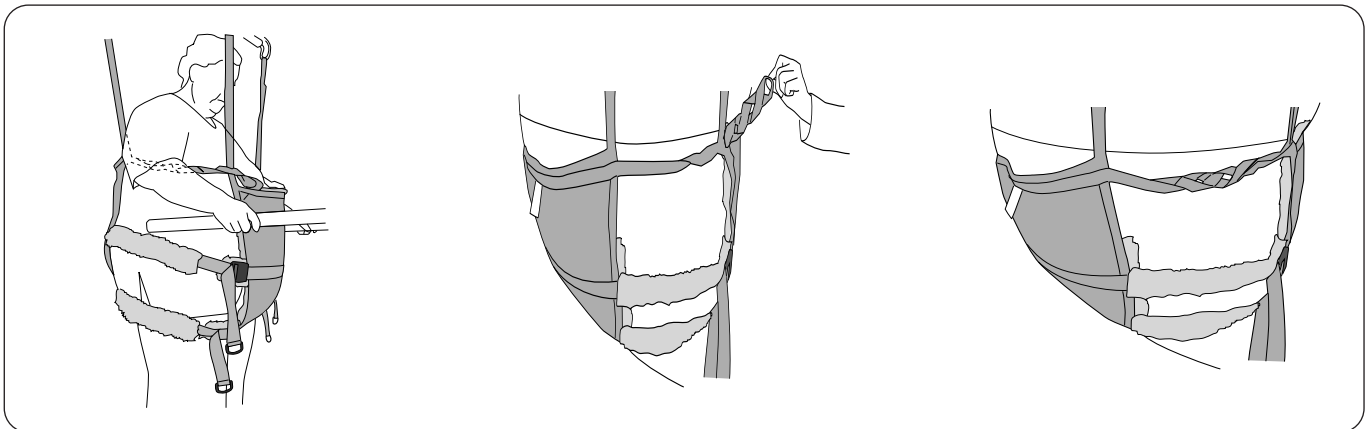

The loop straps should be neither too loose nor too tight around the upper body. Resistance with comfort is best.

A smaller person can have the suspension straps fed through an inner loop.

A larger person can have the suspension straps fed through an outer loop.

Loop Clips

A practical component for indicating the loops that work for a certain person. This makes it easier for caregivers to choose the right loop when applying the Ultra LiftPants sling.

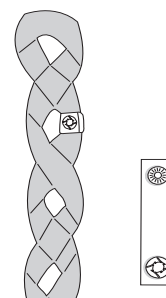

Removing the Ultra LiftPants

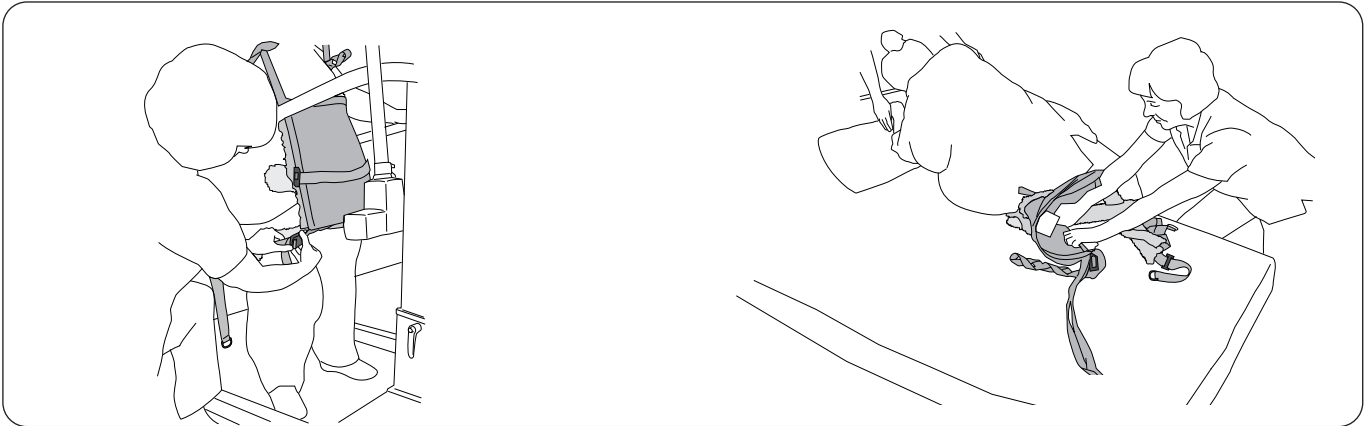

Loosen the hip straps before lowering the patient down into a sitting position to avoid undue pressure from the hip straps.

The patient leans to the side. Seize hold of the outer corner of the rear part of the Ultra LiftPants sling. Now fold the Ultra LiftPants sling in under itself and pull it away.

Accessories

Extension Loop

The Extension Loops come in two different lengths, and in the colors green or grey. The length you choose depends on how great an adjustment you want to make.

Extension Loop, green, 12 cm (5 in)
 Extension Loop, green, 22 cm (9 in)
 Extension Loop, grey, 12 cm (5 in)
 Extension Loop, grey, 22 cm (9 in)

Prod. No. 3691102
 Prod. No. 3691103
 Prod. No. 3691302
 Prod. No. 3691303

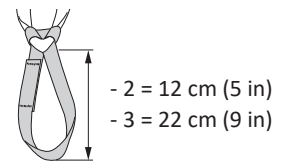

Optional Components

Padded cases for shoulder strap

Prod. No. 3666021

Pressure-relieving padded cases for mounting onto the forward and/or rear suspension straps. The padded cases come with **Velcro** along one longitudinal side for easy mounting.

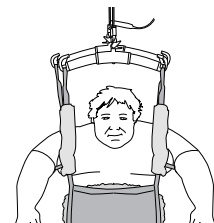

Solo Cover for Ultra LiftPants (XXL/XXXL), 20 pcs

Prod. No. 3692908-2

Solo Cover for Ultra LiftPants sling (XXL and XXXL) is a protective cover made from disposable material. It is used to avoid dirtying the Ultra LiftPants sling and to prevent contagion.

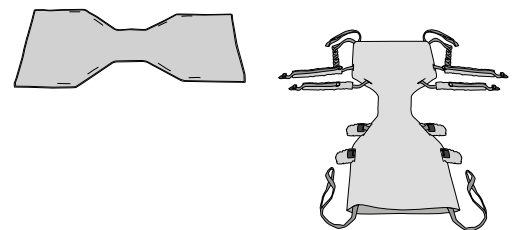

Loop Clips, red, 4 pcs
 Loop Clips, orange, 4 pcs
 Loop Clips, yellow, 4 pcs
 Loop Clips, blue, 4 pcs
 Loop Clips, black, 4 pcs

Prod. No. 3666033
 Prod. No. 3666034
 Prod. No. 3666035
 Prod. No. 3666036
 Prod. No. 3666037

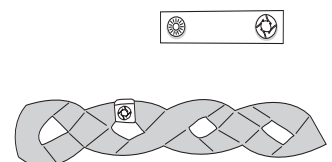

Overview LIKO Ultra LiftPants sling Mod. 920

Product	Prod. No.	Size	Patient weight ¹	Patient height ¹	Maximum load ²	Material
Liko Ultra LiftPants	35920328	XXL	200-500 kg (440-1100 lbs.)	170-210 cm (67-83 inch.)	500 kg (1100 lbs.)	Polyester
Liko Ultra LiftPants	35920329	XXXL	200-500 kg (440-1100 lbs.)	170-210 cm (67-83 inch.)	500 kg (1100 lbs.)	Polyester

¹ The indicated patient weight and height are only guidelines – there may be deviations.

² To maintain maximum load, lift/accessories intended for the same load or more are required.

To choose the right size – refer to “How to Select Size” on page 7.

Recommended Combinations

When using one lift system (LIKOGUARD L and XL overhead lifts, LIKORALL 243 and 250 overhead lifts, VIKING L and XL mobile lifts). The total maximum load for a lift system is always determined by the product in the system with the lowest specified maximum load.

Recommended combinations of the LIKO Ultra LiftPants sling with Liko's sling bars:	Universal SlingBar 350	Standard SlingBar 450	SlingGuard 450	Universal SlingBar 450	Universal SlingBar 600	Universal TwinBar 670	SlingGuard 670 Twin	Sling Cross-bar 450	Sling Cross-bar 670
	Ultra LiftPants, XXL	✓	✓	✓	✓	✓	✓	✓	✓
Ultra LiftPants, XXXL	✓	✓	✓	✓	✓	✓	✓	✓	✓

While this chart serves as guidance, it is important to acknowledge that various circumstances may render sling- sling bar combinations inappropriate. Approved combinations in the matrix must still be assessed and validated by a trained health care professional.

Explanation: ✓ = Recommended

When using two lift units (UltraTwin system), only the below combinations are possible.

Recommended combinations of the LIKO Ultra LiftPants sling with Liko's sling bars:	Universal SlingBar 350	Standard SlingBar 450	Universal SlingBar 450	Universal SlingBar 600
	Ultra LiftPants, XXL	✓	✓	✓
Ultra LiftPants, XXXL	✓	✓	✓	✓

While this chart serves as guidance, it is important to acknowledge that various circumstances may render sling- sling bar combinations inappropriate. Approved combinations in the matrix must still be assessed and validated by a trained health care professional.

Explanation: ✓ = Recommended

Other Combinations

Combinations of accessories/products other than those recommended by Liko can result in risks for the safety of the patient.

Liko, LikoGuard, Likorall and Viking are trademarks of Baxter International Inc. or its subsidiaries.

Any other trademarks, product names or brand images appearing herein are the property of their respective owners.



www.hillrom.com

Liko AB
Nedre vägen 100
975 92 Luleå, Sweden
+46 (0)920 474700

Liko AB is a subsidiary of Hill-Rom Holdings Inc.

Enhancing outcomes for patients and their caregivers:

